

LONDON'S TELEVISION STATION—UNIQUE PICTORIAL SCHEME

Television

and *SHORT-WAVE WORLD*

1/-

MONTHLY

OCTOBER, 1936

No. 104. Vol. ix.

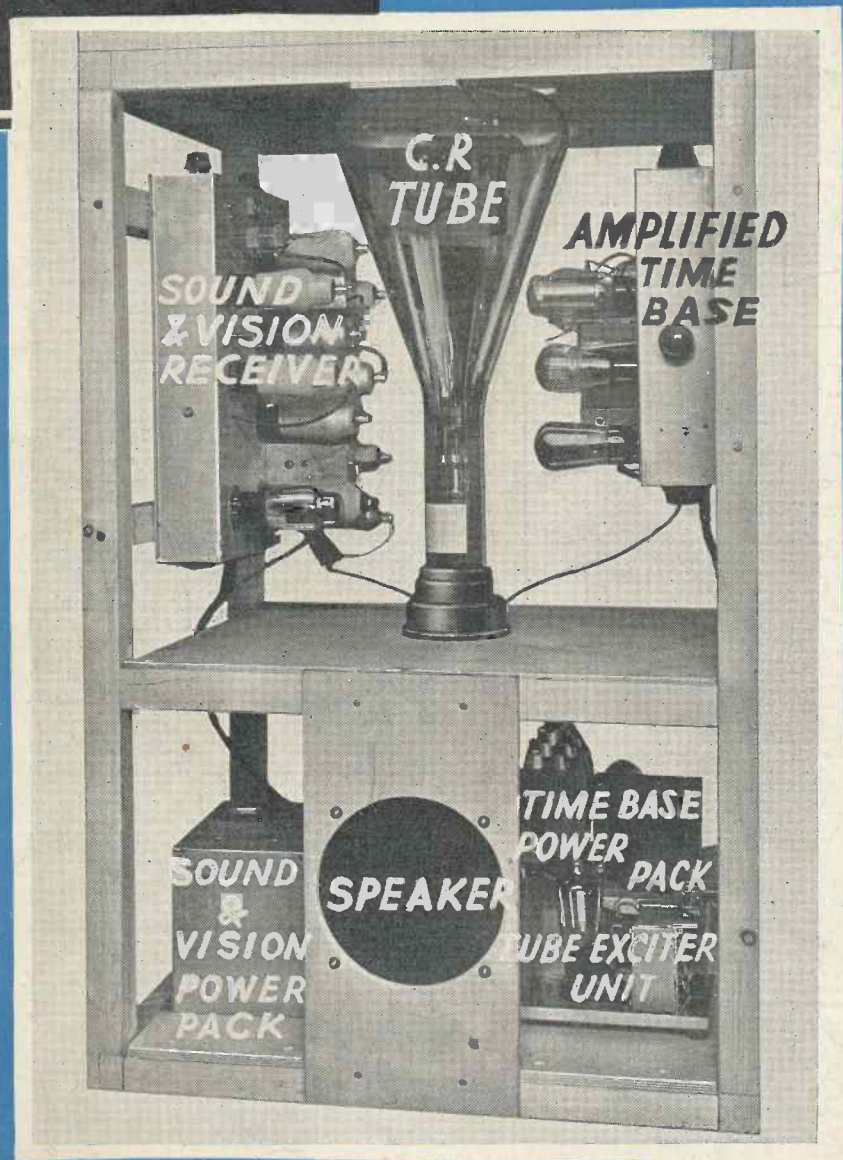

**FIRST
TELEVISION
RECEIVER
FOR
HOME-
CONSTRUCTORS
GUARANTEED RESULTS**

FULL DETAILS

BERNARD JONES PUBLICATIONS LTD.
CHANSITOR HOUSE, CHANCERY LANE
LONDON W.C.2.

THE FIRST TELEVISION JOURNAL IN THE WORLD

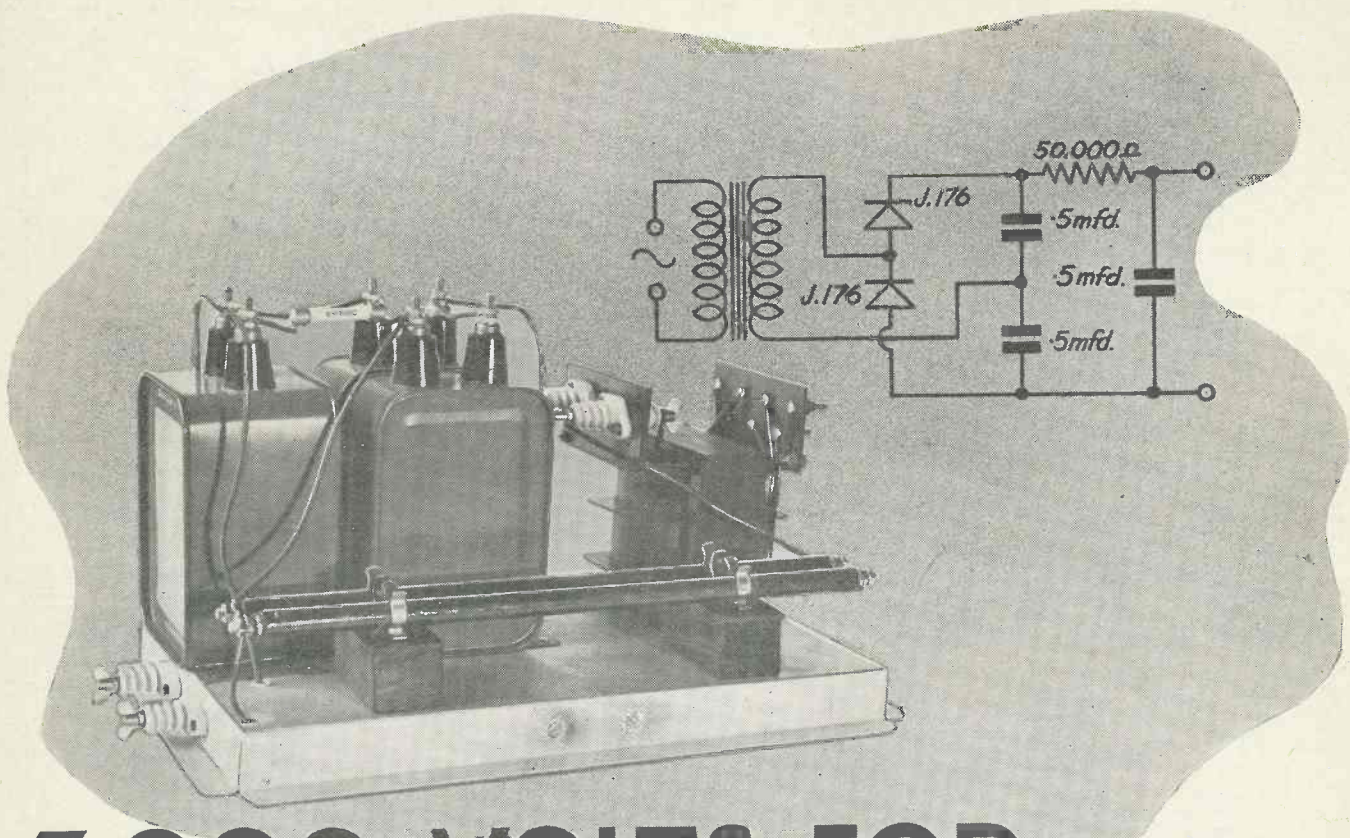

3,000 VOLTS FOR TELEVISION TUBES

The simple and robust unit, for the supply of power to television tubes, shewn above, may be easily constructed by using two of the new J.176 Westinghouse Metal Rectifiers in the voltage-doubler circuit. This enables full-wave rectification to be obtained without resort to the dangerous centre tap method, where the transformer would be called upon to deliver a total of no less than 6,000 volts. The input to the J.176 units is only 1,400 volts, so that the transformer is very much cheaper and less bulky.



Full details of the J.176 type units are given in "The All Metal Way, 1937." A 3d. stamp to Dept. T will bring you a copy by return.



J. TYPE METAL RECTIFIERS

WESTINGHOUSE BRAKE & SIGNAL CO., LTD., 82, York Road, King's Cross, London, N.I.

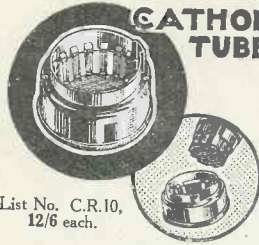

**CATHODE-RAY
TUBE-HOLDER**

A new safety component suitable for modern television apparatus. Fully insulated with removable cover, moulded in bakelite. Integral soldering tags for connections. A moulded key-way ensures correct insertion of tube-base.

List No. C.R.10,
12/6 each.

Suitable for "Osram" and "Mazda" Standard ten-contact tubes. Highly polished black bakelite insulation.

**ULTRA-SHORT-WAVE
H.F. CHOKES**

This special type of low-loss U.S.W. Choke has carefully sectioned windings on a glass former. It is fitted with metal end-caps and 2" wire leads. D.C. $\Omega=8$, 150 $\mu\text{H.}$, 200mA d.c. max., s.c.=below 0.65 $\mu\text{F.}$ For 4.5-45 metres. Peakless choking range.



List No. H.F.21,
1/3 each.

**12-POLE TELEVISION
CABLE-PLUG**

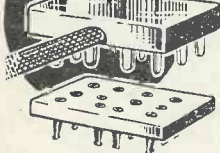

This new fitting meets the requirements of adequate insulation where many poles at high voltages have to be safely and irreversibly connected. Fitted with flat pins, fully insulated, and moulded in highly polished bakelite. Safe and shockproof. Tested at 2,500 v. With terminals for connection.

List No. P.90 (Plug), 5/9 each.
List No. P.91 (Socket) 1/9 each.

**HIGH-VOLTAGE INSULATED
VALVE TOP-CAP
CONNECTOR**



List No. P.92,
9d. each.

This new type of clip-on top-cap valve connector is specially intended for use in and with television apparatus, and with high-voltage rectifiers. Tested at up to 20,000 V. Takes 5 mm. cable and is fully shock-proof. Simply clips onto valve top.

**FLEXIBLE
SHAFT COUPLINGS**

These new fittings will couple all standard $\frac{1}{4}$ in. dia. shafts with several degrees of flexibility. Fitted with 1 in. or 2 $\frac{1}{2}$ in. porcelain insulator for high-voltage working. "Locked" construction which avoids inadvertent loosening. With screws.

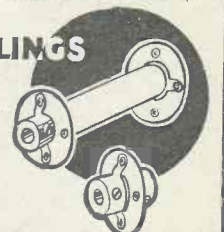

List No. E.H.12, 1 in. insulator, 1/9 each.
List No. E.H.14, 2 $\frac{1}{2}$ in. insulator, 2/3 each.

List No. E.H.15 all-metal 9d. each.
List No. E.H.16 (insulated) 1/- each.

S.W. CONDENSERS

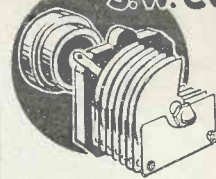

A special type of solidly constructed one-hole-fixing variable condenser with $\frac{3}{8}$ in. dia. bush and $\frac{1}{4}$ in. dia. shaft. Max. 60 $\mu\text{F.}$; minimum, 6 $\mu\text{F.}$ The movement is smooth and noiseless. Fitted with low-loss base and solder-tags ready tuned for connection.

List No. S.W.106 (without knob), 5/9 each.

Suitable control knobs from 4 $\frac{1}{2}$ d. to 8d. each.

7M. TUNING COIL

A simple but efficient low-loss tuning coil for 5-8 metres working. Supplied with or without anode winding. Wound with silver-plated conductor and designed for attachment direct to tuning condenser. May be used in Colpitts circuits. Tune with 50 or 60 $\mu\text{F.}$ condensers.



List No. S.W. 60 (illustrated), 1/6 each.
List No. S.W.61(with reaction), 1/9 each.

RECOMMENDED
AGAIN & AGAIN

BULGIN

QUALITY RADIO
AND TELEVISION
COMPONENTS

COUPON

To Messrs. A. F. Bulgin & Co., Ltd.,
Abbey Road, Barking, Essex.

Please send me Catalogue No. 156 "M" for which I enclose 3d. stamps.

NAME

ADDRESS

(Block Letters Please)

IT'S GOOD TO KNOW

The fact that Sound Sales products are chosen in preference to others is to us, like the personal praise of the boss to a member of the staff. We are, however, quite used to it, and it has always been our honest endeavour to earn such praise.

**For the
TWO STAGE
AMPLIFIER**

the designer has chosen our

**TYPE X 256
TRANSFORMER**

This is of the same high grade construction as our Shielded Super. Every model is flash tested at 3,000v. A.C. In place of terminals the specified model has suitable colour coded connecting wires which can be led through the chassis to correct connection points.

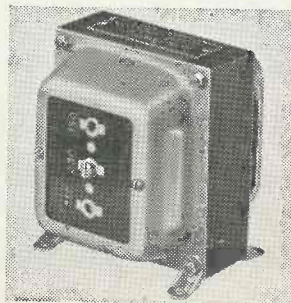

SOUND SALES
Type X256 Mains Transformer
17/6

SOUND SALES
L.F. CHOKES
Type W.W.C.I. 15/-

Specified for the

TOBE RECEIVER

New Catalogue "T.S." Now Ready.

SOUND SALES LIMITED

Marlborough Road, Upper Holloway, London, N.19.

Phone: Archway 1661-2-3.

(Contr. to G.P.O., etc.)

STABILOVOLT

**THE SOLUTION
TO UNSTABLE
SUPPLY VOLTAGE**

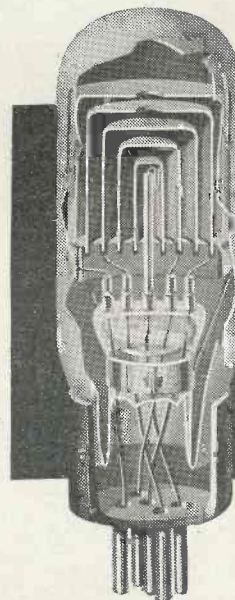
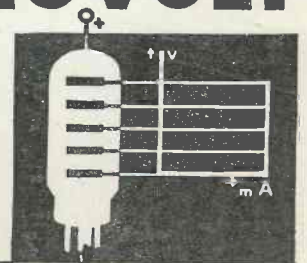

The Stabilovolt tube is a voltage dividing potentiometer and voltage regulator. The voltages tapped are independent to a precision of about .1% from the supply voltage variations, 1-2% from the varying current intensities tapped, .01% from one another. Currents up to 200 mA, voltages of unlimited values subdivided into parts of 70 volts each. Light in weight, small in size, simple and safe in operation.

Prices: Stabilovolt tubes from £1. 16. 0 to £62. Iron Barretters, for use with above, from 16s. to £1. 7. 6. Full particulars from:—

MARCONI'S
WIRELESS TELEGRAPH CO. LTD.
Electra House,
Victoria Embankment, W.C.2.

S2b

TELEVISION

and SHORT-WAVE WORLD

Special Features

| | PAGE |
|---|------|
| Television's Guaranteed Cathode-ray Receiver | 548 |
| Units of a Cathode-ray Receiver ... | 562 |
| Scannings and Reflections | 555 |
| Television Demonstrations at Olympia and Elsewhere | 558 |
| Television Activities of the G.E.C. ... | 560 |
| Features of Commercial Receivers ... | 554 |
| Recent Television Developments ... | 565 |
| Television Without Mains Supplies | 571 |
| The London Television Station ... | 574 |
| The Tobe Amateur Communication Receiver | 583 |
| A 5-8 Metre Sound Receiver | 585 |
| 5-metre Transmitter | 587 |
| Short-wave Radio World | 594 |
| Simple High-fidelity Volume Control | 595 |
| An Automatic Sender for the Constructor | 600 |

COMMENT OF THE MONTH

The Next Step

ALTHOUGH we have information of a quite considerable number of orders having been placed for television receivers, the point needs no stressing that the number that will be in the hands of the public for some time to come will by no means warrant the vast expenditure that is being made for the new service.

In view of the Radiolympia demonstrations we can, we suppose, assume that the direct opposition which television has faced in the past is at an end. Obviously then, the next step in the development of television is to popularise it with the public, and to this end it would seem desirable that there should be a co-ordinated effort by the concerns which are engaged in the manufacture of television receivers. At present prices the "man in-the-street" cannot afford a television receiver, but obviously there are many other outlets. The simple fact must be kept in mind that a television public must be created, otherwise there is the danger of the huge effort that has been made being wasted.

Scanning Lines and Definition

FROM the accounts which we have published of American and German progress it is obvious that the general tendency is to increase the number of scanning lines beyond the minimum standard of 240 set by the Television Committee for this country. The question of line frequency, in our opinion, is chiefly bound up with picture size. We heard no complaints of the definition of the 240-line pictures broadcast from Alexandra Palace; in fact, the general impression was that the clarity was equal to the 405-line transmission. It would seem that a parallel could be drawn with half-tone illustrations; a fine-screen block is useless on a coarse paper such as news-print—the medium is not sufficiently good. At present the same holds good with television, and until further progress in transmitting and other technique has been made an increased line frequency appears unnecessary, though with increased picture size it will become essential.

TELEVISION AND SHORT-WAVE WORLD

Proprietors :
BERNARD JONES PUBLICATIONS, LTD

Editor-in-Chief :
BERNARD E. JONES.

Editor :
H. CORBISHLEY.
Editorial, Advertising and Publishing
Offices :

Chansitor House, 38, Chancery Lane,
London, W.C.2.

Telephones : Holborn 6158, 6159

Telegrams : Beejapee, Holb., London.

Subscription Rates : Post paid to any
part of the world—3 months, 3/6;
6 months, 6/9; 12 months 13/6.

Published Monthly—1/- net.
(Last Wednesday in every month for
following month).

Contributions are invited and will be promptly considered. Correspondence should be addressed according to its nature, to the Editor, the Advertisement Manager, or the Publisher, "Television and Short-wave World," Chansitor House, Chancery Lane, London, W.C.2.

IMPORTANT

"Television and Short-wave World" is registered at the General Post Office, London, for transmission to Canada and Newfoundland by Magazine Post. Entered as Second-class mail matter, Boston, Mass.

TELEVISION FOR THE HOME CONSTRUCTOR—PAGE 548

"TELEVISION'S" GUARANTEED CATHODE-RAY RECEIVER

THE FIRST HIGH-DEFINITION MODEL EVER PRESENTED TO THE AMATEUR CONSTRUCTOR

SIMPLE TO BUILD ACCESSIBLE STANDARD COMPONENTS
UNIT CONSTRUCTION LOW COST GUARANTEED RESULTS

The following article describes the construction of a complete cathode-ray high-definition receiver specially designed for amateur construction. It is suitable for receiving both the Baird and Marconi E.M.I. systems. The cathode-ray tube used is an Ediswan with a ten-inch black-and-white screen. The information given in this article is sufficient to enable the receiver to be constructed, but this will be amplified in succeeding issues and each unit be dealt with in considerable detail.

WHEN the design of this high-definition receiver was contemplated it was decided that three main objectives must be kept in view—first, the construction must be such that it would be within the ability of the average reasonably skilled wireless amateur; second, its construction must not call for the possession of special instruments or tools; and third, it must be entirely accessible so that preliminary adjustments could be made without difficulty.

These objectives have been attained and it will be

found that there is nothing more difficult in its construction than would be experienced with an ordinary sound receiver. No attempt has been made to produce an article of furniture, but the arrangement is such that when the receiver is complete and in working order it can easily be put in a cabinet. Unit construction has been adopted as being the simplest and it will be obvious that if so desired the sound portion can be omitted and an exterior low-priced sound receiver used. The instructions, however, will cover the construction of a complete sound and vision receiver including the various power units.

General Design and Layout

Before describing the construction of the receiver it is necessary to sound a note of warning which is none the less necessary for having appeared before in this journal. The construction of a high-definition receiver with a cathode-ray tube should not be undertaken by inexperienced radio experimenters without the help of someone who is used to experimental work with high voltages.

A great part of the complete receiver is concerned with the supply for the cathode-ray tube which may be of the order of 3,500 volts, and this, while not necessarily being dangerous to life, will give a very severe shock if carelessly handled. The greatest possible care must therefore be taken in the wiring and mounting of the various components to avoid risk of breakdown and the appearance of a high potential in the wrong place.

The components specified can be relied on to perform their work satisfactorily but constructors must assure themselves that every precaution against accidental contact with live parts is taken. During the description of the assembly stress will be laid on the parts of the wiring which require special attention, but in the meantime it must be remembered that the circuits are not the same as the familiar broadcast receiver and that extra care taken in the assembly will be repaid in consistent results.

The whole receiver is assembled in a wooden framework which has been so designed that it can be assembled from battens with the simplest woodworking tools. No special joints have been used, the framework simply being screwed together. Strength is secured by flat pieces of wood being screwed to the framework at

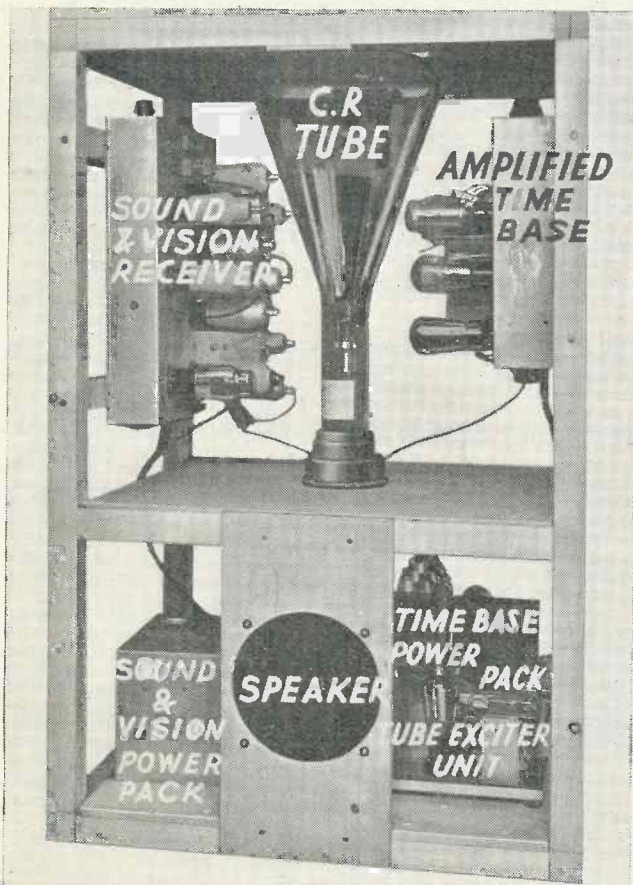

A front view of the receiver showing the positions of the units. The control panel components have been omitted in order not to obstruct the view of the chief units; these of course are of a semi-permanent nature.

VISION & SOUND RECEIVERS

"GUARANTEED"

The television receiver here described and illustrated has been designed and produced by experts working on our behalf for many months.

We guarantee that the picture which this receiver gives compares extremely well with that given by a high-class commercial receiver. It follows that if our readers faithfully follow our instructions in every respect they should produce a thoroughly satisfactory receiver, but certain points must be borne in mind. The reader who has never before had an opportunity of experimenting with a high-definition receiver cannot expect to obtain maximum results until he has acquired some little practical experience. Obviously, he must feel his way, just as he had to feel his way years ago when he started to build broadcast receivers at home.

The precise electrical values of the components is a big factor in success or failure. Those that we specify proved correct in our own receiver, but there is some amount of discrepancy occasionally between the rated values and the actual values of components, and slight variation of this kind is far more serious in a television receiver than in a sound receiver.

In spite of our great care to give all details accurately, it is difficult in dealing with a mass of tiny detail to prevent the creeping-in of some little omission or error; if anything of this sort has occurred in spite of all we have done to prevent it, we will take the first opportunity of publishing a correction.

Subject to the above and to the employment of sound material and components, our readers may, with every confidence, go ahead and build for themselves a first-class receiver which, within the range of the station, will give a good account of the Alexandra Palace transmissions.

We guarantee that our instructions and designs are essentially practical and sound, so much so that we have been able to make an arrangement with a firm of television engineers by which they will, for a moderate fee, bring into working order any receiver which has been built precisely to the instructions here given and with which difficulty is experienced.

the top and bottom of the sides. These are not shown in the photographs as they would obscure the view of the units. When complete the framework may be inserted bodily in a polished cabinet constructed to suit the users' requirements, and can be easily withdrawn at any time for alterations or improvements.

With the object of providing the utmost accessibility, the chassis of the receiver and time base units have been mounted on their sides, exposing the under wiring at the sides of the frame and enabling it to be got at while the receiver is in use. The controls are then brought through the top of the cabinet on long extension rods, leaving a few pre-set controls inside. The change-over from Baird to E.M.I. scanning is accomplished by a switch projecting through the top of the cabinet.

To enable a small depth of cabinet to be used, the tube is mounted vertically in the frame, the viewing being by means of a mirror mounted in the lid of the cabinet. This method saves a considerable amount of space and the loss in efficiency caused by the indirect viewing is negligible. This mirror is not shown as it will form a part of the cabinet and it is quite easy to get the receiver in working order by viewing the top of the tube directly.

The vertical mounting of the tube also allows of the H.T. unit being placed at the rear of the electron beam system, minimising interference. The output leads from the receiver and the time base are as short as possible to avoid loss, and run direct to the socket of the tube which is only a few inches away from the output terminals.

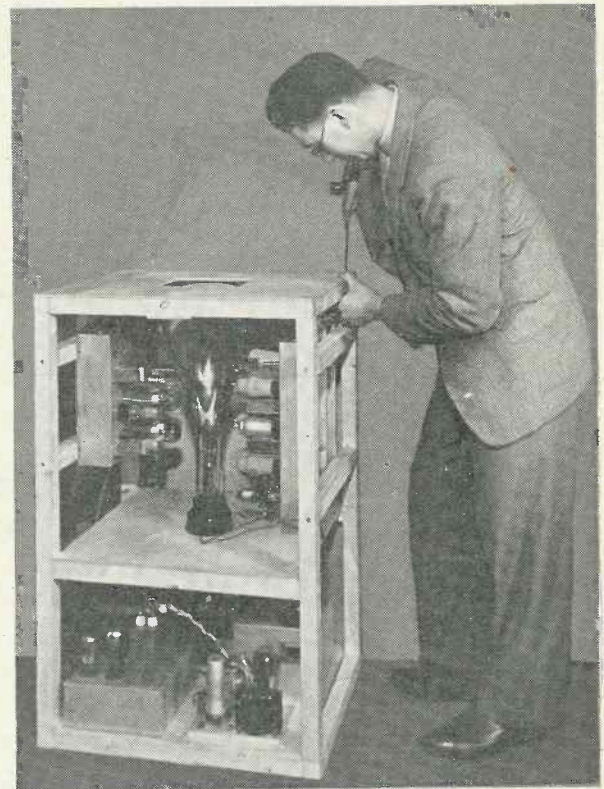

The receiver is quite simple for the average skilled wireless amateur to construct.

The Vision and Sound Receivers

Both vision and sound radio sections are provided on one chassis—the power pack being a separate unit. The dividing shield between vision and sound sections can be seen clearly on the actual photographs. The

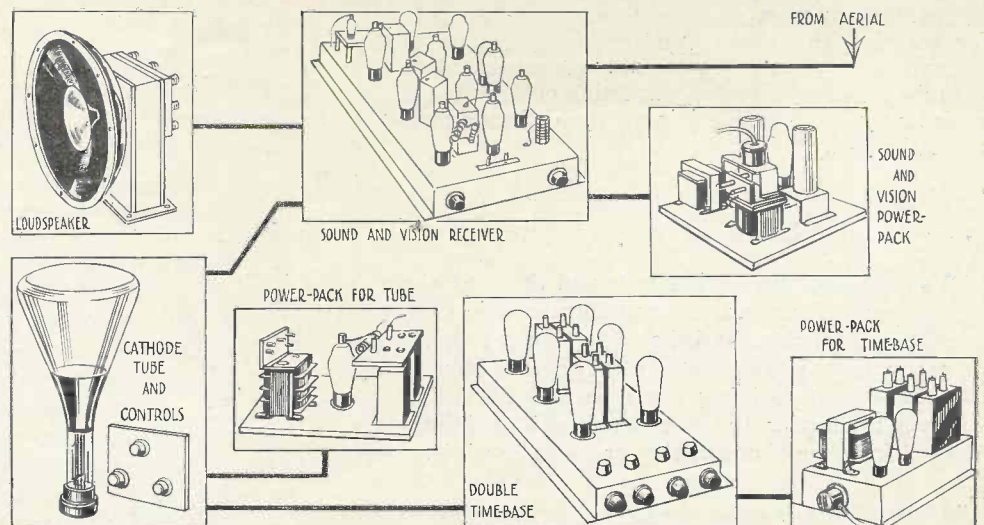

This is a schematic diagram showing the relation of the various units which are employed in the receiver.

EASILY-CONSTRUCTED CHASSIS

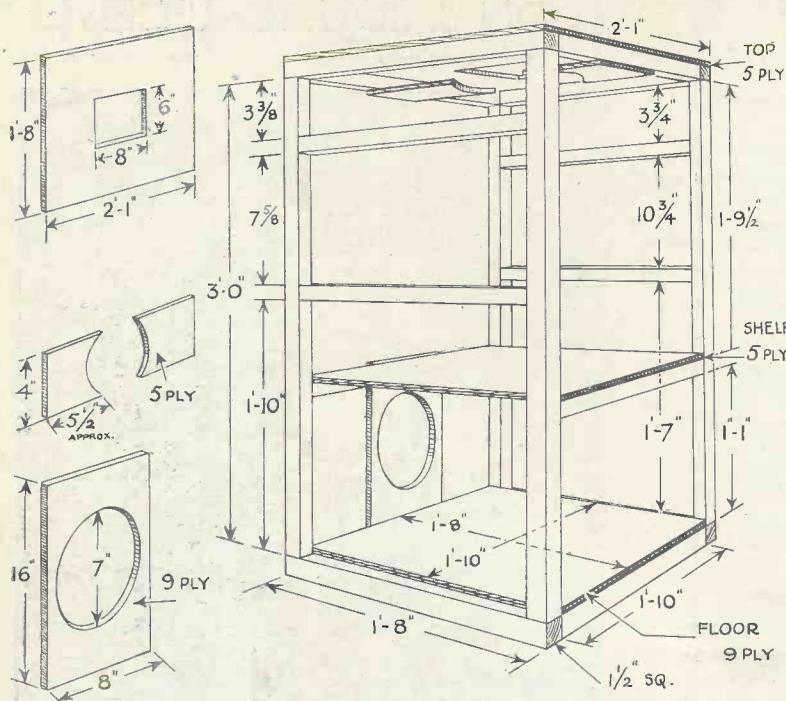

The frame work is constructed without joints and strength is secured by flat wooden pieces screwed on to the outer members of the frame.

receiver is mounted on the left side of the cathode-ray tube which is placed vertically and the two tuning controls are arranged so that it is an easy matter to extend them through the top panel.

The power pack is common to both receivers and is a complete unit. All connections to the receiver proper are made via a multi-point plug and cable. The photographs show the cable which drops down from the chassis to the power pack on the framework base board. The loudspeaker position is also shown.

The amplified double time base (shown in the schematic illustration) is on the right of the tube. The power pack is built in two units, one supplying the power for the heaters, anodes, etc., the other providing potential for centring the picture on the screen. The photographs show clearly the mounting position alongside the tube together with the connecting cable to the power pack and also the cable joining the deflector plates to the cathode-ray tube.

Exciter Unit

We have now the exciter unit and the control panel to consider. These are shown diagrammatically in the schematic illustration and the exciter unit is seen in the photographs. The pre-set control panel is mounted on the base board carrying the tube and the adjustable controls are under the top panel. The former are omitted from the photographs for the sake of clearness.

Framework

The drawing and photographs show the construction

of the frame, which is assembled from 1 1/2-in. square planed battens. The method of joining these is left to the discretion of the constructor, but those who are not expert in woodwork will find that a secure joint is made by means of small angle brackets 2 ins. x 2 ins. mounted in the corners, or the framework can be simply screwed together. As additional stiffening, flat angle straps may be fastened to the joints at the edges. Any tendency of the framework to wobble will be corrected when the shelves are inserted, but the whole frame should be trued carefully before screwing down the plywood shelves. Outer pieces of plywood (not shown in the photographs) will make the whole assembly quite rigid.

The wood required for the frame is as follows:—6 pieces each 1 ft. 10 ins., 4 pieces each 3 ft., 4 pieces each 1 ft. 5 ins., 4 pieces each 1 ft. 8 ins. The above measurements are neat, i.e., they do not allow anything for morticing is required. The shelves are cut from 1/2 in. plywood and are cut to fit the frame.

It is possible to cut the upper shelf from 1/4 in. plywood but greater strength is obtained by the thicker wood. The lower shelf can be screwed into place on the bottom battens by means of No. 8 countersunk woodscrews, 5 per side, spaced equally.

Before the upper shelf is fitted the centre should be marked by drawing two intersecting diagonals and the hole pricked for the tube socket. The dimension given on the drawing is for an average length of Ediswan 10OH tube, but as a certain tolerance is allowed on overall length, the batten may have to be shifted slightly when the tube is finally mounted. It should, therefore, be held in place by angle brackets only until the correct position is found. The correct height of mounting for the tube is that which just brings the top of the domed end level with the top batten. When the framework is finished a masking sheet of thin plywood will be placed over the top of the tube and a sheet of plate glass will be framed in the centre of the mask to protect the tube from damage.

On the under side of the top battens two pieces of plywood will be required to hold the tube steady. These have semi-circular pieces cut out, through which the tube is threaded and placed in the socket. The tolerance on the length of the tube will again affect the spacing of this shelf and size of hole and final screwing down should not be done until the tube is in place.

Having marked all the holes, assemble the frame to see that it is true, including the shelves, and mark the front of the frame for reference. Then the shelves can be removed for fitting the components. The cross battens for holding the chassis on each side of the tube can be secured in place with screws run right through the side uprights, as these will not need to be altered.

OCTOBER, 1936

VISION RECEIVER CIRCUIT

The most important unit is the vision receiver and the following constructional information will enable anyone to duplicate the results.

The circuit arrangement shows a pre-tuned H.F. stage in order to obviate special aerial arrangements and improve the signal-to-noise ratio; this is followed by a triode hexode stage as first detector and frequency changer. The output of this is passed to and amplified by 4 I.F. transformer coupled stages. The output is then passed to a diode as a second detector which is directly coupled to the cathode-ray tube—this is explained more fully later on. A further stage is also coupled to the valve preceding the diode and arranged as an anode-bend detector; this provides a synchronizing signal that can be selected and applied to the double time base.

If we divide the vision receiver into three units the construction will be found to be very easy.

The chassis can be obtained with all valve holders and insulated plates mounted in position, as it is found to be more convenient and does not increase the cost.

The Eddystone tuning condenser is mounted on a stout bracket which is bolted to the chassis and the slow motion drive projects through the front. No dial is fitted other than that supplied with the Eddystone slow motion drive head. It is not necessary to do so as an indication of the tuning position only is required.

The grid coil, with a trimmer across it, for the buffer stage is underneath the chassis and is soldered directly on to the valve holder and a lead is taken to the aerial input. The ceramic trimmer is not mounted but is soldered direct to the coil as once set it will need no further adjustment. From the top cap of this valve a lead is taken directly to the H.F. choke which is a special Mervyn type and also to the T.C.C. mica coupling condenser. The other side of this coupling condenser goes direct to the grid coil (with a trimmer soldered across it) of the triode hexode valve. As the grid of this valve is brought out to the top cap a short self supporting coupling is provided. Here again, once the trimmer is set, no further adjustment is required. Signals are received without adjusting but it does allow the coil to be tuned.

The oscillator coils for the triode section of the triode

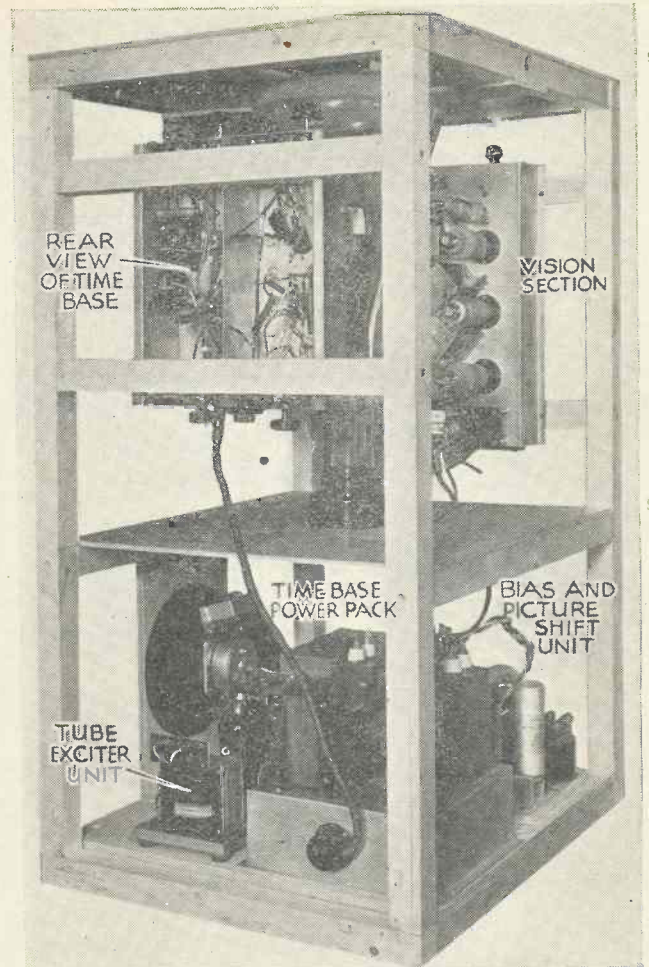

This is a rear view showing the disposition of the units.

hexode valve are also wired directly to the valve pins and these coils should be either purchased or wound with four turns each. No. 16 bare copper wire spaced approximately half the wire diameter between turns is satisfactory. These are then wired so that they are spaced about $\frac{1}{8}$ in. apart. It is quite satisfactory to have them self supporting. To test the oscillation place a m.a. meter in series with the 50,000-ohm leak and cathode and adjust the coupling for a reading of 0.2 m.a.

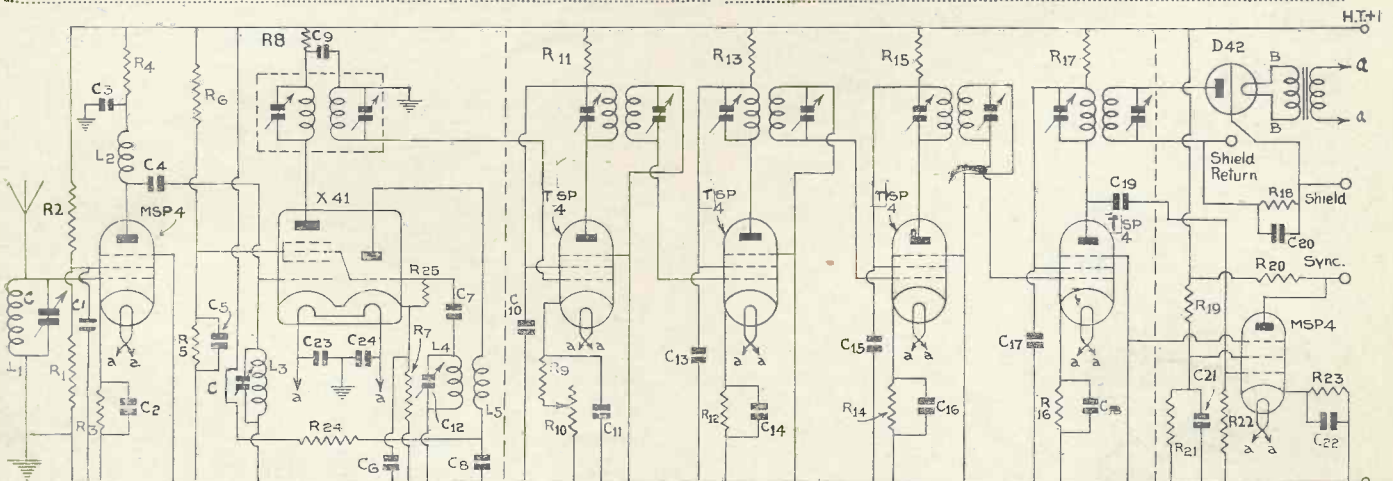

The circuit of the vision receiver. The dotted lines show the three sections, viz.: H.F. and frequency changer section, I.F. amplifier and detector, and synchronizing section. The I.F. transformers are supplied ready wired which simplifies the actual construction very considerably.

THE I.F. AMPLIFIER

Notice carefully that the Eddystone tuning condenser is across the grid coil. The grid leak and condensers are mounted in the wiring and will not be found to present any difficulty.

Heater leads are of twisted flex and taken neatly to

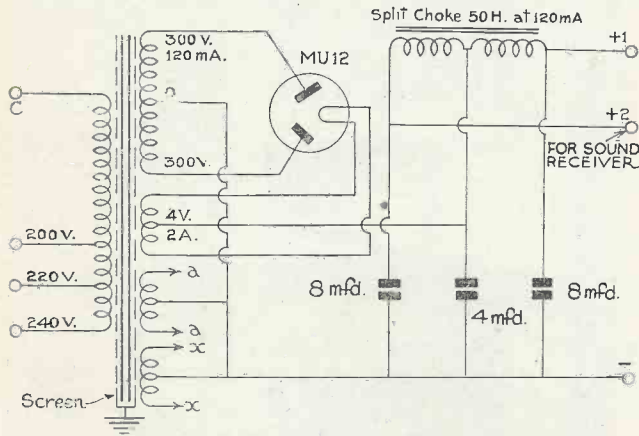

Circuit diagram of power pack for vision and sound receiver.

each valve holder. The two buffer condensers on the triode hexode valve are wired on to the valve holder and chassis. It is important not to omit these otherwise modulation hum will be troublesome.

The resistance and condenser networks, to give the required working voltages, are wired directly to the valve holders and not taken to a central distribution board as in some broadcast receivers. This applies throughout the circuit. In the receiver a main H.T. line should be taken the whole length of the receiver

and leads soldered on opposite the valve holders. This facilitates wiring the return leads from the I.F. coils and prevents the bunching of leads together.

A variable resistance is used in series with the first I.F. cathode resistor and its purpose is to adjust the sensitivity and prevent the I.F. amplifiers going into oscillation. Once set it need not be touched. It is positioned on the chassis by the side of the first I.F. can and the valve.

I.F. Amplifier

The I.F. amplifier does not need a great deal of explanation. The I.F. transformers are of a special shielded plug-in type so that the wiring is very much simplified. The chassis is provided with Clix 4-pin sockets which are easily wired. Bear in mind that the pin corresponding to the anode pin of a valve is plus H.T. The decoupling resistance is then joined between this pin and H.T. plus. The screen grid of the TSP₄ and one side of the decoupling condenser are also soldered to this pin. The pin corresponding to the grid of the valve is taken to the plate of the preceding valve, in the first case the X₄₁, and subsequently the TSP₄'s. The left-hand filament pin (when looking from under the chassis) is the shielding can while the other pin is the earth end of the grid coil. In this receiver both are taken to earth.

The grid connection to the next valve is taken through the top of the I.F. can and is fitted with a valve top connector. The TSP₄'s have the top cap as the input or control grid and it is therefore only necessary to join the lead to this cap.

A point of interest are the I.F. transformers which are of a special type developed by Mervyn and are sup-

LIST OF COMPONENTS FOR VISION RECEIVER

CHASSIS.

1—Aluminium to specification (Burne Jones).

CONDENSERS, FIXED AND VARIABLE.

- 2—30 m.mfd. trimmers type 1023 (C) (Eddystone).
- 1—.1 type PCP₁ (C₁) (Bulgin).
- 1—.1 type PCP₁ (C₂) (Bulgin).
- 1—.1 type PCP₁ (C₃) (Bulgin).
- 1—.0005 type M (C₄) (T.C.C.).
- 1—.1 type PCP₁ (C₅) (Bulgin).
- 1—.1 type PCP₁ (C₆) (Bulgin).
- 1—.0001 type M (C₇) (T.C.C.).
- 1—.1 type PCP₁ (C₈) (Bulgin).
- 1—.1 type PCP₁ (C₉) (Bulgin).
- 1—.1 type PCP₁ (C₁₀) (Bulgin).
- 1—.1 type PCP₁ (C₁₁) (Bulgin).
- 1—900140 (C₁₂) (Eddystone).
- 1—.1 type PCP₁ (C₁₃) (Bulgin).
- 1—.1 type PCP₁ (C₁₄) (Bulgin).
- 1—.1 type PCP₁ (C₁₅) (Bulgin).
- 1—.1 type PCP₁ (C₁₆) (Bulgin).
- 1—.1 type PCP₁ (C₁₇) (Bulgin).
- 1—.1 type PCP₁ (C₁₈) (Bulgin).
- 1—.0005 type M (C₁₉) (T.C.C.).
- 1—.0001 type M (C₂₀) (T.C.C.).
- 1—.1 type PCP₁ (C₂₁) (Bulgin).
- 1—.1 type PCP₁ (C₂₂) (Bulgin).
- 1—.01 type 300 (C₂₃) (T.C.C.).
- 1—.01 type 300 (C₂₄) (T.C.C.).

COILS.

- 1—6 turn type 1050 (1) (Eddystone).
- 1—6 turn type 1050 (3) (Eddystone).
- 1—4 turn type 1050 (4) (Eddystone).
- 1—4 turn type 1050 (5) (Eddystone).

CHOKES, HIGH-FREQUENCY.

1—Type T.U.S.1 (2) (Mervyn).

HOLDERS, VALVE.

- 7—Chassis mounting type standard, 7-pin (Clix).
- 4—Chassis mounting type standard, 4-pin (Clix).

PLUGS, TERMINALS, ETC.

- 1—Aerial connecting plug type 1047 (Belling Lee).
- 1—Insulated plate fitted with 2 sync. and 1 earth terminal (Belling Lee)
- 1—10 point plug type 1251 (Belling Lee).

RESISTANCES, FIXED AND VARIABLE.

- 1—50,000 ohm type 1 watt (R₁) (Erie).
- 1—50,000 ohm type 1 watt (R₂) (Erie).
- 1—100 ohm type 1 watt (R₃) (Erie).
- 1—1,000 ohm type 1 watt (R₄) (Erie).
- 1—50,000 ohm type 1 watt (R₅) (Erie).
- 1—50,000 ohm type 1 watt (R₆) (Erie).
- 1—200 ohm type 1 watt (R₇) (Erie).
- 1—1,000 ohm type 1 watt (R₈) (Erie).
- 1—100 ohm type 1 watt (R₉) (Erie).
- 1—10,000 ohm variable potentiometer (R₁₀) (Bulgin).
- 1—1,000 ohm type 1 watt (R₁₁) (Erie).
- 1—250 ohm type 1 watt (R₁₂) (Erie).
- 1—1,000 ohm type 1 watt (R₁₃) (Erie).
- 1—250 ohm type 1 watt (R₁₄) (Erie).
- 1—1,000 ohm type 1 watt (R₁₅) (Erie).
- 1—250 ohm type 1 watt (R₁₆) (Erie).
- 1—1,000 ohm type 1 watt (R₁₇) (Erie).
- 1—20,000 ohm type 1 watt R₁₈ included in diode assembly (Erie).
- 1—50,000 ohm type 1 watt (R₁₉) (Erie).
- 1—20,000 ohm type 1 watt (R₂₀) (Erie).
- 1—20,000 ohm type 1 watt (R₂₁) (Erie).
- 1—1 megohm type 1 watt (R₂₂) (Erie).
- 1—2,500 ohm type 1 watt (R₂₃) (Erie).
- 1—20,000 ohm type 1 watt (R₂₄) (Erie).
- 1—50,000 ohm type 1 watt (R₂₅) (Erie).

SUNDRIES.

- 1—Bracket for condenser drive (Mervyn).
- 1—Cord cable (Mervyn).

TRANSFORMERS, I.F.

- 4—Special shielded type TIF₁ (Mervyn).
- 1—Special shielded unit complete with diode D₄₂ valve and R₁₈ and C₂₀ (Mervyn).

TRANSFORMER, MAINS.

- 1—Special 4 volt with 3,000 volt installation type TAI (Savage).

VALVES.

- 2—MSP₄ (Marconi).
- 1—X₄₁ (Marconi).
- 4—TSP₄ (Mullard).

DETAILS OF TIME BASES

plied pre-tuned, adjusted and completely shielded. From the anode of the last TSP₄ amplifier a small T.C.C. mica condenser is connected with its associated leak to the control grid of the MSP₄ valve used for synchronising. This MSP₄ is arranged as an anode-

are between the cathode and heater and between primary and secondary of the I.F. transformer. The primary and secondary of the I.F. transformer are specially made to withstand this potential difference. The heater is supplied *via* a small transformer which is ex-

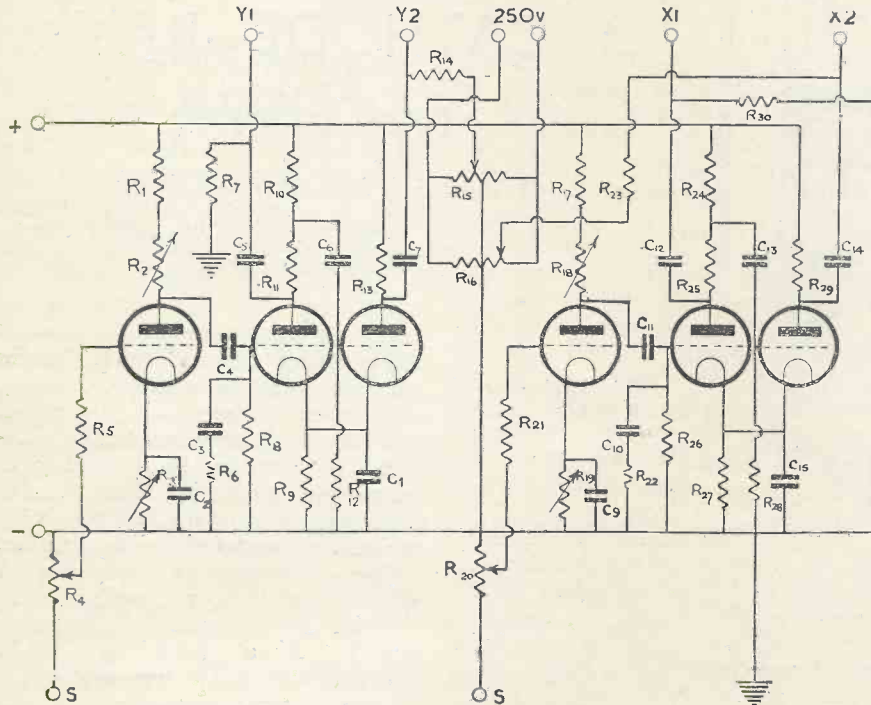

The time base circuits. Constructional details of this will be given next month.

- Components for
POWER UNIT OF VISION AND
SOUND RECEIVERS**
- BASEBOARD.**
1—Wooden baseboard to specification (Mervyn).
- CASE.**
1—Metal protecting case (Burne Jones).
- CONDENSERS, FIXED.**
1—4 mfd. electrolytic type DWL 1764 (Hunt).
1—8 plus 8 mfd. electrolytic type DWL 2657 (Hunt).
- CHOKE, LOW-FREQUENCY.**
1—Split choke 50 henry 120 Ma (Sound Sales).
- HOLDER, VALVE.**
1—4-pin chassis mounting type standard (Clix).
- PLUGS, TERMINALS, ETC.**
1—Mains input connector type 1014 (Belling Lee).
1—Bracket complete with 10 point (Belling Lee) socket (Mervyn).
- SUNDRIES.**
1—Bracket for valve and electrolytic condenser (Mervyn).
- TRANSFORMER, MAINS.**
1—Special to specification (Bryan Savage).
- VALVE.**
1—U 12 (Marconi).

bend detector with an anode resistance of 20,000 ohms. A lead from the MSP₄ anode is taken to each of the synchronising terminals.

A special unit for the detector is supplied completely assembled containing the last I.F. transformer, the diode and its associated resistance and condenser.

The secondary side of this unit has to be completely

cited from the 4-volt heater winding and has a secondary to provide the voltage for the diode heater. It is best to connect the primary to the synchronising MSP₄ heating pins. Therefore, it is only necessary to see that the insulation of the primary and secondary of this transformer can withstand the potential difference. This transformer is mounted under the chassis of the receiver below the special I.F. diode unit. Two leads, well insulated, are brought out from this unit which are connected to the cathode-ray tube.

Time Base Unit

The time base used is of the ordinary thyratron type with a stage of push-pull amplification to provide symmetrical deflection and to keep the striking voltage of the thyratron low. The overall H.T. voltage is 1,200, giving ample voltage swing across the anode resistances of the valves for full deflection. The theoretical circuit is shown by the diagram. The speed of scan is controlled by the resistance R₁ and R₂ and R₁₇ and R₁₈ and these have to be adjusted to suit both the E.M.I. and Baird systems. From the list of values it will be noted that the resistances are 3.0 meg. and 2.5 meg. for Baird and 0.5 meg. and 0.5 meg. for E.M.I. It will, therefore, be necessary to insert a pre-set resistance which can be adjusted and then cut in or out by a short-circuiting switch. Two ganged switches will then serve to change the scanning system completely. There is also the question of compensating for the different picture ratio, but it will be found in the preliminary setting up that this can be disregarded.

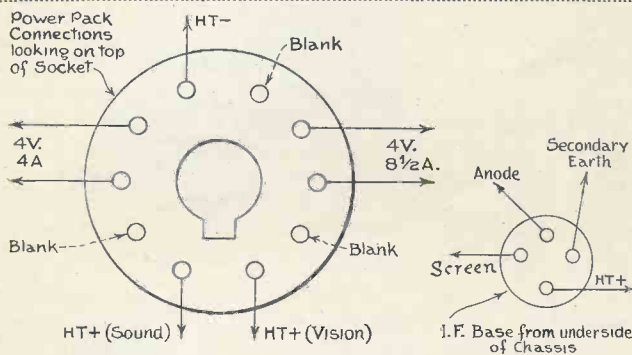

Left. Top view of power pack connecting socket. Right. Underside view of the connection to the I.F. sockets.

isolated from the rest of the receiver as there is at least 3,000 volts difference in potential between it and the receiver. Very novel means are employed to ensure this. The diode load is seriesed with the cathode-ray shield connection, and as no H.T. is applied to the anode, the only places where a short circuit could occur

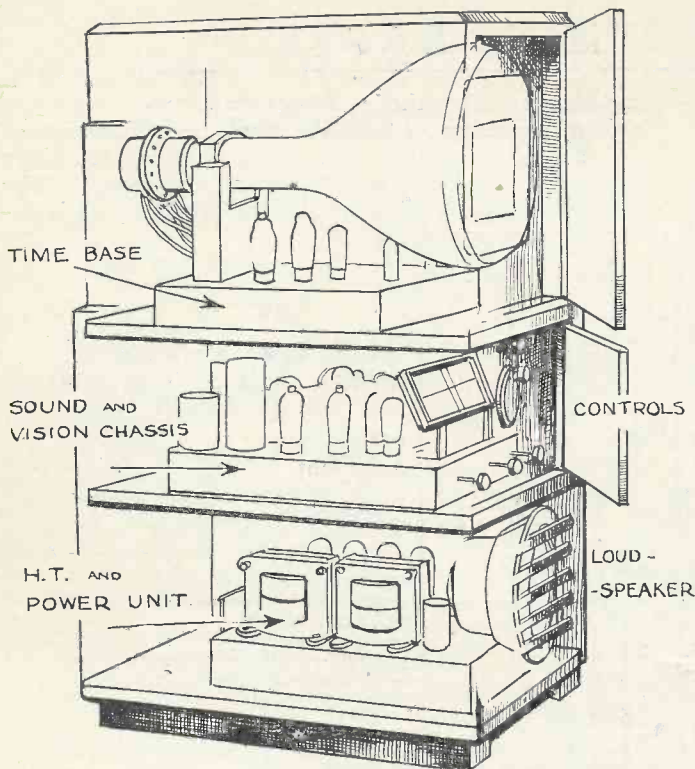

FOR THE BEGINNER

THE UNITS IN A CATHODE-RAY RECEIVER

This article is intended to help all those beginners interested in television who were bewildered by some of the specifications of the new television receivers.

This is mounted with the controls at the top or front of the cabinet in some position where they are easily get-at-able. A mains unit giving high tension, etc., is also needed to energise this receiver, but contrary to normal practice, it is a good idea to mount this unit at the bottom of the cabinet and connect it to the receiver.

Then comes a second receiver which is much more complicated as it is for the reception of the vision signals. As a general rule, eight valves are needed in this unit which is invariably a super-heterodyne circuit, although one or two manufacturers are still advising the use of a tuned R.F. receiver.

This set has a high-frequency stage, not so much to give gain at 6 metres, but to isolate the detector

(Continued on page 607).

MOST readers are acquainted with the construction of a radio receiver. They also know how it is built up of several units and have a rough idea of how these units are inter-connected. There is, of course, the high-frequency amplifier, the detector, low-frequency amplifier, loudspeaker, and either a mains power pack or high-tension batteries and accumulators. All these separate sections linked together make one receiver to pick up sound programmes.

With these points in mind, many readers have told us how they tried to disentangle all the units in the commercial television receivers and tried to gain some idea as to how all of the various parts were inter-connected.

Very few were able to discover very much except that a large number of valves, varying between 18 and 30, were used. There is very little difference between a commercial television receiver and an instrument built by the home constructor. The only difference will be that the commercial article, for example, makes one power pack provide high tension and heater current for both sound and vision receivers. In some cases the commercial instrument will have a combined receiver for both sound and vision. These little variations do not affect the fundamental arrangements as far as the constructor is concerned.

In this issue several of the com-

mercial instruments are illustrated showing the ideas embodied in the housing of all the different sections. First of all, a receiver has to be built for listening to the sound programmes on 7.23 metres. Generally speaking, this is a four or five valve super-heterodyne. Constructors living very close to the transmitting station will probably use a more simple receiver of two or three valves, but the fact remains, the first item is a sound receiver and loudspeaker.

This sketch shows the various units of a Cathode-Ray Receiver.

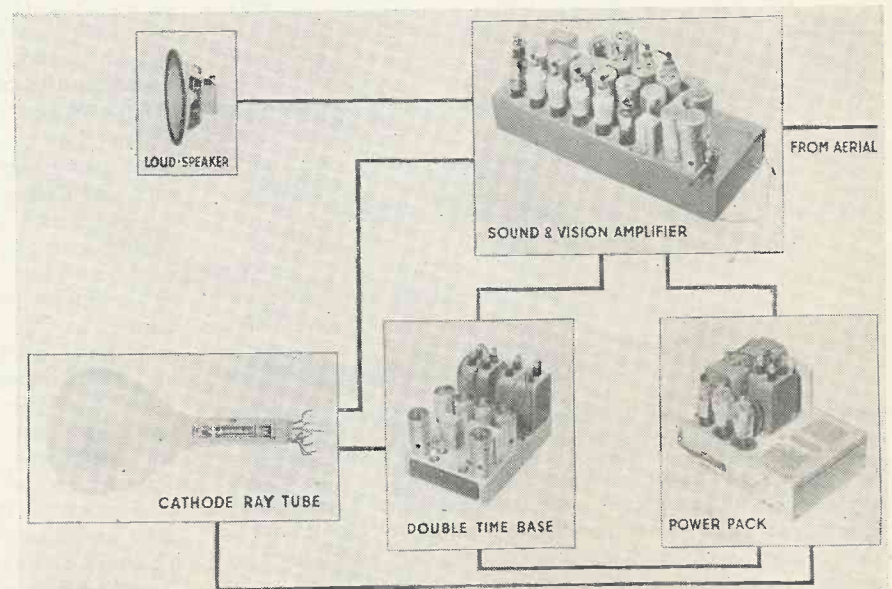

The units of the G.E.C. Receiver shown schematically.

Scannings and Reflections



TELEVISION'S DEBUT

An Unqualified Success

EVEN the greatest opponents of television have been unable to deny that it is an unqualified success and that results obtained, even in this initial stage, have come as a great surprise. The change of front is rather amusing. There are dozens of instances where a matter of a month or so ago the public were being led to suppose that television was five years away; it is now being acclaimed as the latest wonder. Opposition still exists in some quarters and a second line of defence has been set up that it is costly and intricate and pertinent references are being made to the expenditure necessary for the maintenance of the service.

WHEN THE PROGRAMMES WILL START

A Month of Tests

At the time of writing, except for a few odd short-period transmissions, Alexandra Palace has closed down in order that the finishing touches can be put on the equipment and various adjustments made. About the beginning of October, however, a period of test transmissions are to commence which it is expected will last a month. These are primarily intended for the benefit of the trade and the B.B.C. and as far as possible the public will be kept informed of the hours at which the transmissions will take place. At the end of this test period the inauguration of the regular public television service will take place. It is expected, therefore, that the public service will commence early in November.

THE TECHNICAL HITCH

Considering that very hurried preparations had been made for the Radiolympia demonstrations, the technical hitches that occurred during the whole run were surprisingly few and what there were were quickly rectified. The first occurred on the

occasion of a Press visit the day before Radiolympia opened its doors to the public. Considerably over an hour passed beyond the scheduled time before it was announced that some difficulty had arisen and that some further delay was inevitable. The derisive laughter which met the announcement made it clear that most of those present expected that this would be the first of a series of many hitches. Events, however, proved that they were wrong, for this particular trouble was the most serious and took a longer time to rectify than any which occurred during the whole period of transmission.

THE ATTEMPT AT SABOTAGE

The serious attempt made to wreck the television demonstrations at Radiolympia was revealed by a meter reading which showed an apparent short circuit. Investigation showed that a piece of tin-foil had been inserted in a plug socket with the object of causing a short circuit. This appeared to have been deliberately done and moreover it was thought that it could only be the work of someone who had some considerable knowledge of the working of the apparatus. After this occurrence a stricter watch was kept on the gear by officials of the exhibition.

An official statement describing the incident read as follows:

"During one of the morning tests previous to the opening of Radiolympia at the beginning of last week an engineer proceeded to connect the equipment by inserting a jack into its proper plug points and so connect the eight booths with the central amplifier. The voltmeter immediately registered a short-circuit, which might have dislocated the apparatus and caused 7,000 volts short-circuit.

"On investigation it was discovered that a wad of tin foil had been inserted in the plug points. This had the appearance of being deliberately done, and, moreover, only a technician could have appreciated the possible result."

TELEVISION THE PREMIER ATTRACTION AT OLYMPIA

No check was kept on the number of people who witnessed the television demonstrations at Olympia, but from rough counts of the sizes of the queues on several occasions the general impression has been formed that the total number approximated nearly 160,000, or about three-quarters of the total attendance at the exhibition, if those who made more than one attendance be excluded. The total attendance at Radiolympia exceed that of last year by rather more than 10,000, a figure which undoubtedly was due very largely to the added attraction provided by the television demonstrations.

PROHIBITION NOT IN FORCE AT ALEXANDRA PALACE

It came as a surprise to many of the party of visitors to the Alexandra Palace when it was first shown to members of the Press that the refreshments provided were not entirely teetotal. Wines, spirits and beer are strictly taboo at Broadcasting House and this occasion establishes a precedent. We learn, however, that there is no intention of drink being available to artists. Another unusual procedure was the holding of the Press visit on a Sunday which, of course, was due to the last minute decision to demonstrate television on the following Wednesday at the wireless exhibition.

TELEVISION AT WATERLOO STATION

No Interference from Electric Trains

The five-minute sessions of television at Waterloo Station proved a great success. There, any holder of a Southern railway ticket could watch the transmission for five minutes, after which the "house" was cleared to admit another party. The rush for admission revealed the great amount of public interest.

MORE SCANNINGS

TELEVISION HISTORY

Most readers of this journal will be familiar with the design of the original apparatus used by Baird in his early experiments. Mr. Baird has now presented this apparatus to the Science Museum at South Kensington, London. Made from old bicycle parts, tins, bullseye lenses, etc., at a total cost of 7s. 8d., it was the forerunner of modern television.

DON LEE (U.S.A.) TELEVISION

Sound via KHJ—Sight over W6XAO

Recently the Don Lee Broadcasting System broadcast for the first time, the "sound" phase of a news-reel over KHJ and the "sight" portion of W6XAO, simultaneously; the united sight-and-sound was picked up at a private residence, $3\frac{1}{2}$ miles removed from both transmitters. The receiver was located behind a hill but there was no difficulty in picking up the transmission.

THE RANGE OF THE ALEXANDRA PALACE TRANSMISSIONS

No authentic records are so far available as to the range of either the sound or vision transmissions from Alexandra Palace. Confirmed reports on reception have been received from Ely, Banbury, Bournemouth, Southend, Tunbridge Wells, Clacton and an unconfirmed report from Exeter.

A field strength of 20 microvolts is obtainable at Cambridge when using a half-wave vertical aerial in the centre of the town.

These reports indicate that the range of the transmissions will greatly exceed the supposed 25 miles. Listeners should be able to hear the sound programmes at distances of at least 100 miles if the aerial is erected in a high un-screened position.

TELEVISION SIGNALS WITH AN ALL-WAVE RECEIVER

Many reports have been received from readers who have been able to receive the television sound signals, radiated on a wavelength of 7.23 metres, on the overtones at approximately $14\frac{1}{2}$ and 29 metres. Readers situated as far as Cambridge have reported that they can hear the sound programmes at very good strength

and quality on standard all-wave receivers such as the Pye Tro.

Those who are in possession of an all-wave or short-wave set will find it of interest to listen on these two wavelengths directly the regular television programmes start.

Reports on reception of television sound signals on any wavelength other than the fundamental of 7.23 will be appreciated.

THE LAST OLYMPIA TRANSMISSION

The television transmissions were due to finish at six o'clock on the Saturday evening the Wireless Exhibition closed, but so great was the crowd at Olympia waiting to see the demonstrations that the programme had to be continued on impromptu lines for three-quarters of an hour.

TELEVISION IN AN AEROPLANE

Last month the Baird Company demonstrated one of their receivers in an aeroplane flying at a height of 4,000 feet above London. It was afterwards stated that the pictures were quite clear and that at a height of 2,000 feet reception was perfect. No interference from the ignition system of the plane was experienced.

TELEVISION RELAYS

A broadcast relay concern in Norwich is experimenting with a view to relaying the television programmes to its subscribers. The idea, apparently, is to instal central time bases in order to supply subscribers with the line and scanning frequencies. Also there would be a central receiver for sound and vision and these signals would be transmitted along with the synchronising impulses. Individual receivers would consist merely of a cathode-ray tube provided with suitable filter circuits. It is, of course, uncertain whether it will be possible to pick up the Alexandra Palace transmissions at such a distance and the scheme, although not without possibilities, presents very many technical problems.

HOTELS AND TELEVISION

A Pioneer

Brent Bridge Hotel, Hendon, claims to be the first hotel in the world to instal a television receiving set to give its customers the benefit of the new service free of charge. It is stated that the results obtained are excellent.

DEMONSTRATIONS IN CINEMAS

It is understood that tentative approaches have been made to West End cinemas with the suggestion that television receivers should be installed in their lobbies, etc., in order to demonstrate the home instrument. These, it is assumed, would be installed free of charge in return for the publicity that would result.

A TELEVISION SCHOOL

Instruction in Televising

A school of television broadcasting is to be opened near Leicester Square, W.C. Two studios will be provided, one equipped with a spotlight scanner for close-ups, and the other with floodlights for extended views. Instructions will be given in television make-up, dress and microphone technique.

PRESENTATION TECHNIQUE

As the ten days of transmissions to Radiolympia proceeded it was evident that those responsible for presentation were learning a lot, for towards the latter part of the session there was a noticeable improvement in this respect: The weakest part seemed to be the head-and-shoulders appearance of the announcer, which appeared to spring from nowhere. A similar feeling was created later on when the announcer suddenly appeared seated at a desk; in those instances where he could be observed walking on to the "set" an immediate knowledge of his identity and purpose was obtained. It seems very apparent that the identities of the announcers should be preserved, and in this respect it appeared to be a mistake for them to join with the artists in a *grand finale* in a way somewhat reminiscent of the closing scene in a pantomime.

INTERFERENCE IN NORTH LONDON

Broadcast listeners in North London are complaining that the Alexandra Palace transmissions are causing interference with the ordinary sound programmes. This interference is variously described as consisting of ghostly whisperings, ringing bells, road drills and sharp staccato reports like machine gun fire, which on occasion completely blot out medium-wave transmissions. The B.B.C. state that they have received complaints from a few listeners and that it is

AND MORE REFLECTIONS

probable that the sets in question were not sufficiently selective, the probability being that a harmonic of the television wavelength is picked up. The districts chiefly affected are Campsbourne, Hornsey, Crouch End and parts of Muswell Hill.

NEW SHORT-WAVE STATIONS AT DAVENTRY

Stations to Cost £100,000 each

The race for world supremacy in short-wave transmission started by Germany is getting keener with the announcement by the B.B.C. that they are to erect four new short-wave stations so as to have world-wide coverage for the Empire programmes. These stations will be of high power and it is anticipated that the cost will be nearly £100,000 per station.

Just recently Empire listeners have been complaining about the terrific power of the German and Russian transmitters who put out propaganda programmes with great persistency.

New B.B.C. stations with beamed aerials should give unrivalled service for almost 24 hours a day, so with the B.B.C. getting down to the gigantic task of entertaining the whole world, great times are ahead for Colonial and foreign listeners.

SIX NEWS BULLETINS A DAY

British Licences pay for the Empire Service

Talking about Empire programmes, the six news bulletins broadcast each day through the Daventry short-wave stations can be picked up in this country on most short- or all-wave receivers.

One bulletin in particular should interest English listeners who like to hear the latest news before breakfast, for it is broadcast at 7.55 a.m. on 19 and 31 metres.

Sports events are often recorded and re-broadcast the next day on short-waves, so if any important news or event has been missed on the local station, do not forget the Empire programmes.

AMERICAN CONSTRUCTOR SETS
Are they Superior to British Receivers?

British amateurs have generally been of the opinion that American short-wave receivers are vastly superior to anything that can be pro-

duced on this side of the Atlantic. This reputation has largely been built up by reports obtained from foreign listening stations and from advertisements.

During the past few months one or two of the more prominent American sets have come into this country and been put through their paces. So far results have not been too good, for although the receivers have worked fairly well, they have not been up to expectations, neither have they proved any better than some of the good British sets. It seems that the large number of valves does not necessarily mean better performance, while it is admitted that the noise level is often high. Some of the American commercial receivers, such as the Hammarlund, Tobe or National, are in a class of their own, but the majority of imported receivers have yet to prove their suitability for British amateur use.

A REVIVAL IN RECEPTION CONDITIONS

Simple Sets can Receive Australia

As all listeners know, the past three or four months have been very bad indeed for reception of long-distance stations.

There is, however, now every indication that the improvement noticed towards the end of September will be more or less permanent. Many listeners have reported a good reception of Australian stations during the morning until about 11 a.m., while American amateurs are now being heard at a strength comparable with that experienced during the peak periods of recent years. Those listeners who became despondent at the continued lack of results during the summer should again try out their receivers while the conditions are so good.

AMERICAN TELEVISION STANDARDS

The tentative standards more or less agreed upon for television in the United States are already showing their effects upon the design of television receivers.

Read
Television and Short-wave World
Regularly

The latest design for the Farnsworth receiver tunes in both sound and vision by means of a single knob. Also a dial is used for tuning.

It has been admitted that each television station in the United States should have a band five megacycles in width. It has also been tentatively agreed that there be a fixed separation between the sound and vision bands; this is, for the present, three-and-a-quarter megacycles. Thus, with a fixed separation of three-and-a-quarter megacycles between sound and vision for all television stations, it is merely a matter of design to make the tuning of the sound and vision easily possible with one knob. Thus sound and vision are tuned-in simultaneously.

For example, with a station assigned 62.75 megacycles, the vision band will extend from 60.25 to 65.25 megacycles. Sound will be then at 66 megacycles. Since the band width for sound is only about 10 kilocycles, the "guard band" between vision and sound is three-quarters of a megacycle.

THE EARLY TELEVISION BROADCASTS

Featuring a Horse Race

The B.B.C. are preparing some exciting programmes to be broadcast from Alexandra Palace this month. Henry Hall is to appear in a full-length programme during the afternoon session of October 7. This programme will be available to anyone with a television receiver or to those who can tune down to 7 metres to hear the sound programme.

Henry Hall will broadcast over the National station at 5.15 that afternoon and will use for the first time the Alexandra Palace studios instead of the usual Maida Vale dance music studio.

Alexandra Park races are taking place on October 10, so the B.B.C. are to make the most of this opportunity and will broadcast at least one of the races.

The Cathode-ray Tube at Work.

—In our review of this book in last month's issue no mention was made of the price. The price is 11s. post free.

THE TELEVISION DEMONSTRATIONS

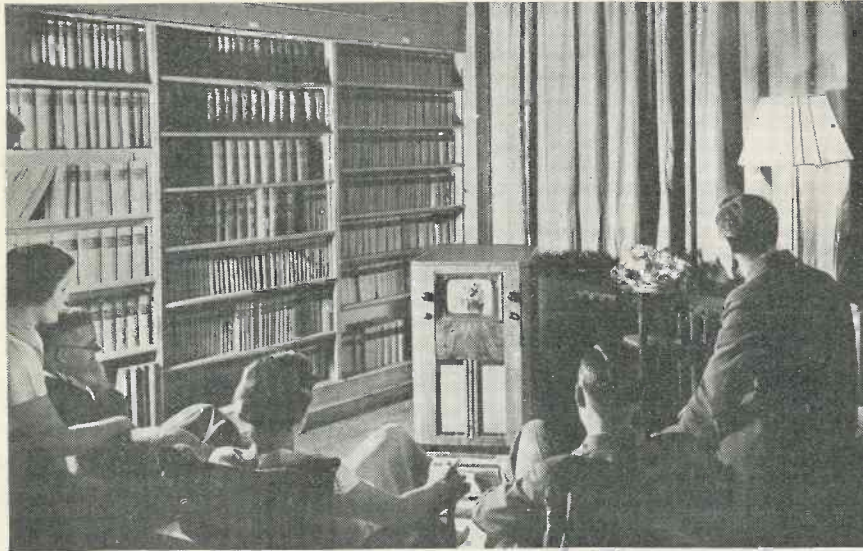

This photograph shows a G.E.C. television receiver in the home.

AT OLYMPIA — AND ELSEWHERE

By
The Editor.

At the Baird Offices

Fortunately, I was, of course, able to see the transmissions under more favourable circumstances than at Olympia. The first I saw was at the Baird offices in the Haymarket—and what a contrast to the Olympia demonstrations. When I entered the room the transmission had just commenced; the picture was on the screen with a brightness and definition at a distance of six feet which was amazing.

This particular transmission was by the Baird system and one is rather inclined, unconsciously, to associate the receiver with the system; actually, of course, the receiver is equally suitable for either one transmission system or the other, and this applies to all receivers. Upon looking at the picture for the first few moments there was a perceptible flicker and the first idea was that it might become trying to watch for any length of time. Curiously enough, after a very few minutes this flicker seemed to disappear and it was only after about an hour that a chance remark of another visitor to the effect that since the beginning he had not noticed any flicker that recalled its existence. It seems clear that our eyes quickly adjust themselves to the conditions so that after a few minutes flicker is unnoticeable.

The picture on this receiver remained perfectly steady and at a constant level of brightness for the duration of the full programme, which lasted about an hour and a half, in fact, except for the first five minutes there was no official present to make any adjustments.

Although the receiver was in the heart of London, interference was practically absent, despite the fact

HAD my observations of the transmissions from the Alexandra Palace been confined to those which I saw at Olympia I am afraid that my idea of the entertainment value would not be any too high—and yet on all sides I heard expressions of admiration of the results which most of the public had seen for the first time. The plain fact is that the showmanship was of the worst, although possibly it was excusable on account of the small amount of time which was available after a decision had been reached to include the demonstrations in the wireless exhibition.

To set a small picture in the middle of a large black expanse was the first error; it was altogether too reminiscent of a peep-show. Then there was no indication that different receivers were being operated in the four different booths and the result was that those who were by chance unfortunate to see the poorer reproduction came away with an erroneous impression. Even without disclosing the makes of the different receivers it would have been possible to indicate that the receivers were different. The majority of visitors were under the impression that only Baird and Marconi-E.M.I. receivers were being demonstrated; those that did know differently had perforce to queue up four times and so spend the best part of a couple of hours.

Considering the very large number

of people who wished to see the demonstration it was perhaps unavoidable that they should be quickly hustled through, but surely a better setting could have been obtained by having the actual receivers (all cabineted alike if that was necessary) arranged on a raised dais to bring them to a suitable eye level and to have allowed the queue to pass round the whole lot. This point is mentioned for it is a very different matter to view a television picture in the setting for which it has been intended and under the conditions at Olympia. The idea of keeping the makes of the various sets secret was futile and those who had any curiosity regarding them easily found a means of satisfying it. Actually the firms represented were Baird, Cossor, Edison, Ferranti, G.E.C., Marconi-E.M.I. and Phillips.

The choice of film material, particularly during the first few days, was bad. The film *Poste Haste* was a particularly bad example, for a large part of the pictures were "stills," evidently taken from some book. Those who were unfortunate enough to be passing through a booth during a transmission of this must have obtained a quite erroneous idea of television. Later on this film was taken off, though the other one, "Cover to Cover," which was not the most suitable selection that could have been made, was maintained for the whole series of transmissions.

MARCONI E.M.I., G.E.C., AND PYE DEMONSTRATIONS

that there was a lift operating a few feet away. What interference there was merely appeared as pin points of light which occasionally flashed across the screen.

Marconi-E.M.I. Reception

A demonstration of the Marconi-E.M.I. receiver was given at the Gramophone Company's recording studios at St. John's Wood. We were warned before the transmission started that there would possibly be interference from the diathermy apparatus from a near-by hospital, and this, in fact, did appear as a sort of moiré pattern over the picture at intervals. Passing traffic and electrical apparatus in the same building had no perceptible effect.

This particular transmission was by the Marconi-E.M.I. system and there was no flicker whatever. The picture left nothing to be desired for the whole period of the transmission and it remained perfectly steady. An engineer sat by the controls which he occasionally adjusted, but it appeared to us that this attention was unnecessary for only very rarely did any adjustment he made make any real difference to the picture.

240 or 405?

Our impression of the relative number of scanning lines in the two systems is that no greater detail is provided by the larger number, but this, of course, is a matter which will only be decided after a lengthy trial. Possibly imperfections in transmission, spot size and line register account for this. At one time during this transmission sufficient light was switched on to enable a newspaper to be easily read and still the brightness of the picture was adequate enough to give full entertainment value; this at once disposes of the idea that lookers must sit in the dark.

This particular demonstration was given at a later date than that of the Baird and the programme matter had been improved. Also it was demonstrated how the Emitron camera can make a change from a distant shot to a close up and how by the use of two or more cameras different scenes can be faded one into the other. For example on one occasion a full-length picture was shown of a girl dancing. This slowly "dissolved" into a close-up of the

girl's legs and feet and this further "dissolved" into a close-up of the pianists' hands.

G.E.C. Television at Wembley

The G.E.C. television demonstration was staged for a comparatively large audience, which totalled about a hundred. On this account five receivers were operating at the same time. These five receivers were placed in a line and it speaks well for their performance and the clarity of the pictures that even those who

angle; in the case of this group of G.E.C. receivers this was very slight even though the angle in some cases was over forty-five degrees. With only one exception did any of the five receivers require any attention and this merely necessitated a slight turn of one of the controls. Later a transmission was made from one of the transmitters in another part of the building. These transmitters employ discs and the transmission was from a film with a radio link. The reproduction fully came up to the standard of the Alexandra Palace transmissions.

A Demonstration by Pye

The Pye demonstration which we saw was rather marred by interference from motor-car ignition systems. It appeared that the demonstration had been hurriedly arranged and that no noise suppression aerial had been erected; this trouble, it is understood, was rectified later and severe interference was not experienced afterwards. A noticeable feature of the Pye picture is its extreme brightness, so bright is it in fact that it can comfortably be viewed in ordinary room lighting. In this case also the receiver was not given any attention whatsoever during the whole period of the transmission. Brightness and contrast were maintained the entire time and the picture remained perfectly steady. The picture is viewed directly on the end of the tube and therefore no light is lost by reflection.

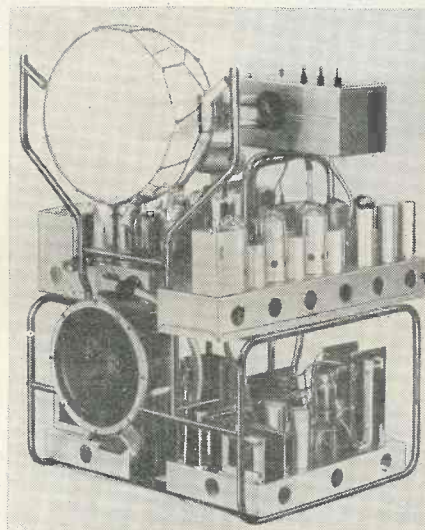

The chassis of the Pye receiver is of tubular metal. Note the neat suspension of the tube.

were sitting at the back were able to view the programme without any difficulty.

The operation of five receivers at the same time enabled an interesting comparison to be made, for it was possible to dissociate what might be receiver faults from transmission faults. It was observed throughout that each of the receivers was consistent and that any observable fault appeared on each, which clearly showed that it was due to some variation in transmission. Also it was possible to make a comparison of the difference due to viewing

Baird Television, Ltd.

The seventh ordinary general meeting of the company was held at Film House, 142 Wardour Street, London, W.1, on Friday, September 18, 1936. On account of the recent activities of the company in completing, at short notice, the installation of the necessary apparatus at Alexandra Palace, which fully occupied the time of the company's directors and staff, the completion of the audit of the accounts to June 30, 1936, it was stated, had been delayed.

At this meeting the chairman proposed a resolution to the effect that the meeting be adjourned until October 16, 1936, at Caxton Hall, Westminster, S.W.1.

TELEVISION AT THE BERLIN RADIO EXHIBITION

Owing to the special demands upon our space in this issue we are obliged to hold over the description of the television exhibits at Berlin until next month

THE TELEVISION ACTIVITIES OF THE G.E.C.

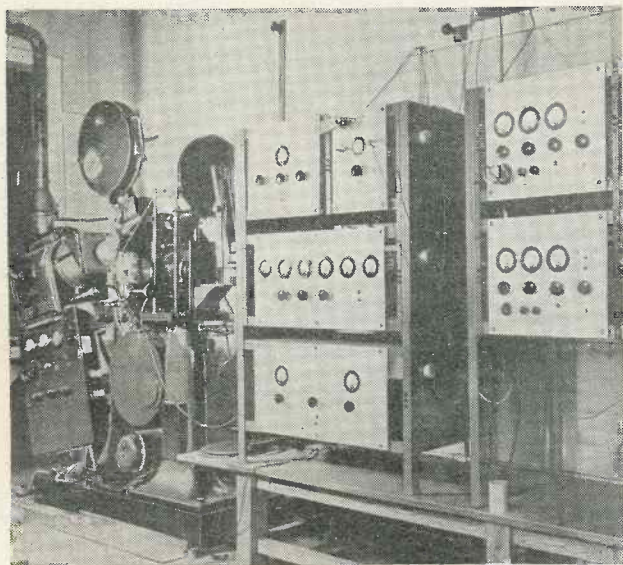

A disc transmitter for films used for experimental transmission of sound and vision at the G.E.C. Research Laboratories; ultra-short wave panels on the right, and picture amplification and synchronisation panels in centre.

FROM time to time we have published brief accounts of the part the General Electric Company has been playing in the development of television. As much of the research work was of a confidential nature, naturally it was not possible to publish any details. It is significant, however, that the largest electrical concern in the country quite early realised that television was a definite possibility and straightway proceeded to equip a section of the G.E.C. laboratories at Wembley specially for television research. In addition, work was carried out at the wireless works of the Company at Coventry and the valve works at Hammersmith. These proceedings enabled the G.E.C. to investigate every branch of television development.

The G.E.C. Transmitter

In order that the work would not be dependent on outside transmissions two high-definition transmitters were installed at the Wembley laboratories, one largely for radio transmission and the other for a wire channel; here experimental work on the 7-metre wavelength was carried on with a view to improvement of transmission and reception methods. These transmitters have many unique features which we hope to describe in detail in a future issue. Concurrently with the development of transmission methods, investigations were started

on the theoretical design of receiver circuits, leading to the evolution of production models in co-operation with the wireless works at Coventry. Intensive research was also conducted on the design of cathode-ray tubes. Actually, the company has a special department for the development of fluorescent materials which are now becoming so widely used for lighting purposes, and naturally this department played its part in finding the most suitable material for the coating of the cathode-ray tube.

To supplement its own work on television the G.E.C. has an arrangement for interchanging technical information and patents with the Loewe Company which occupies an important position in this field on the Continent.

The recent result of these activities has been the commercial production of two fully developed and tested television receivers. One of these models is designed for sound and vision reception, being capable of dealing with both types of B.B.C. transmission, and is priced at 95 guineas. The other incorporates, in addition, an all-wave broadcast receiver and costs 120 guineas. The total power consumption is 240 watts.

Receiver Construction

The sound and vision receiver, whether used by itself (in the smaller model) or in conjunction with an all-

An account by the Editor of a personal visit to the television laboratories of the G.E.C. at Wembley

wave broadcast receiver (in the larger), consists of four units: (1) Sound and vision chassis; (2) double time base chassis; (3) power pack; and (4) cathode-ray tube assembly.

The sound and vision chassis provides the whole of the amplification for the sound and vision signals. Output connections supply the picture frequency voltage for application to the cathode-ray tube, and separated synchronising impulses.

A short-wave aerial is connected to the input of an MSP41 valve which functions as a fixed tuned radio frequency amplifier, common to sound and vision channels. A single frequency changer employing an MX41 valve automatically locates the sound and vision signals in their respective intermediate frequency amplifiers.

The vision amplifier uses one VMP4G and four MSP41 valves followed by an A748 rectifier and N43 output stage. The output circuit is such that the true average picture brightness is accurately maintained. A D41 rectifier separates the synchronising impulses from the combined picture and synchronising

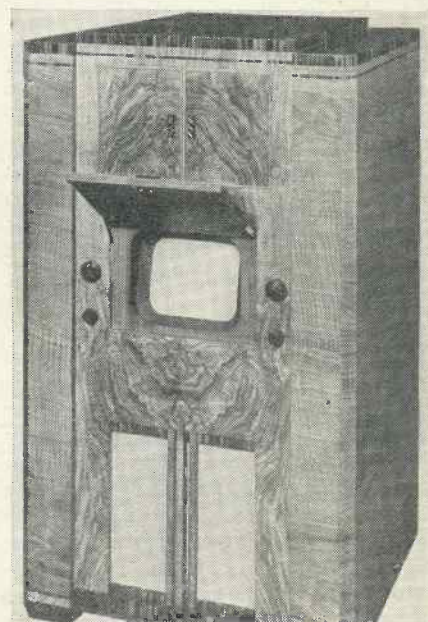

The G.E.C. high-definition television receiver. Another model includes an all-wave receiver.

G.E.C. CONTROLS

signals in the output circuit of the N43.

In the sound amplifier one VMP₄G and one MSP₄ work as I.F. amplifiers with an MHD₄ and MPT₄ as detector and power output stage.

Double Time Base

The double time base employs two specially developed GT1B gas-filled relays working as low voltage relaxation oscillators to generate the saw-tooth voltages for deflecting the scanning spot over the picture area of the cathode-ray tube. One of these gas-filled relays is associated with the vertical or frame deflection, and the other with the horizontal or line deflection. Each relay is followed by a pair of MH₄'s at the output of which is obtained a balanced saw-tooth voltage of the amplitude necessary for spot deflection.

The power pack provides power for the operation of the complete receiver. One transformer and MU₁₄ rectifier supply the H.T. and heater voltages for the sound and vision chassis. A separate transformer and two UI₇ rectifiers working in a special circuit provide the various H.T. and heater voltages for the cathode-ray tube and double time base chassis. All smoothing circuits are included in this unit.

Adjustment and Controls

Ordinarily all that is required to receive a picture is the turning of the "on-off" control to the position corresponding to the transmission system in use at the time. Only minor adjustments are necessary to maintain the best receiving conditions, these being made by the

The chassis of the G.E.C. receiver includes many special features; note the metal-cased tube and the tube inclination. The power packs are in a separate chamber in the base.

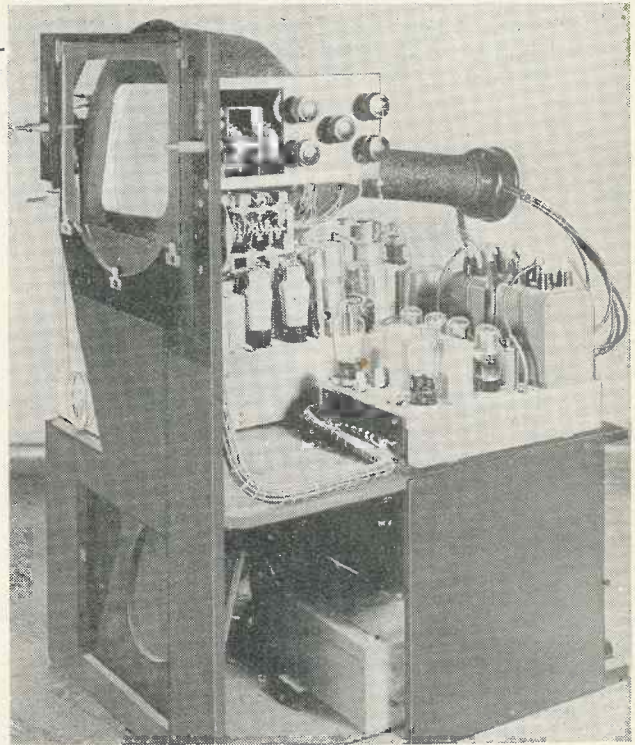

controls on the front of the cabinet. The controls beneath the small side panel are of a semi-permanent nature and are set up before the receiver is installed.

Actually, twelve controls are provided, but as stated, most of these need never be touched.

A special feature in these processes is the use of a bulb that has an almost flat end which, considering the pressure which it has to withstand, is a remarkable production. The bulb is enclosed in a strong metal container for screening and mechanical protection, and as it is comparatively short it can be used in a horizontal position.

The main electrode structure of the tube is rigidly supported on large

metal rods to ensure perfect stability and alignment. Electrostatic deflection is used for both the vertical and horizontal spot movements, and the deflecting plates are shaped so as to give a picture free from shape distortion.

The G.E.C. television receivers are, of course, specially designed for receiving the B.B.C. transmissions from Alexandra Palace. A simple switch allows the set to be changed over from one system to the other.

A 12-in. tube is employed giving a picture approximately 9 ins. wide by 7 ins. high, a size that should prove satisfactory for all home requirements and at the same time ensures the very high degree of "brightness" essential for a satisfactory picture. The picture is screened directly on the end of the tube and the height and inclination of the picture screen have been chosen to correspond to the normal line of sight of a person comfortably seated in a chair. The accompanying sound is reproduced in the ordinary way on a high quality moving-coil speaker of the permanent-magnet type. Sound and vision are tuned in simultaneously by adjusting a single knob. A total of 23 Osram valves are employed.

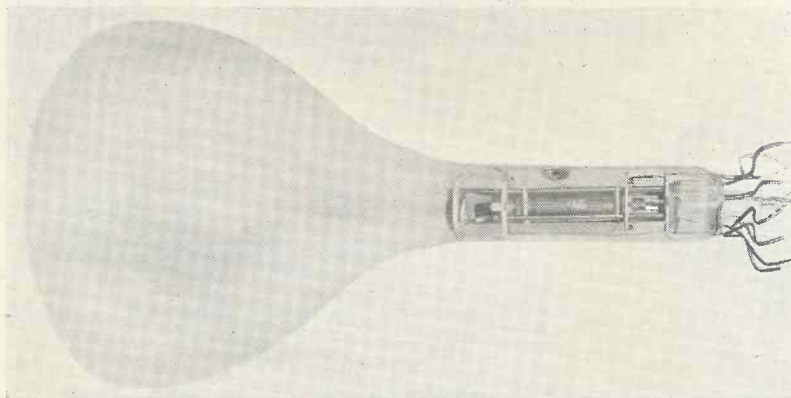

The G.E.C. cathode-ray tube; its small length enables it to be used in a horizontal position without the necessity for an unduly large cabinet.

**READ TELEVISION
& SHORT-WAVE WORLD
REGULARLY**

FEATURES OF COMMERCIAL TELEVISION RECEIVERS

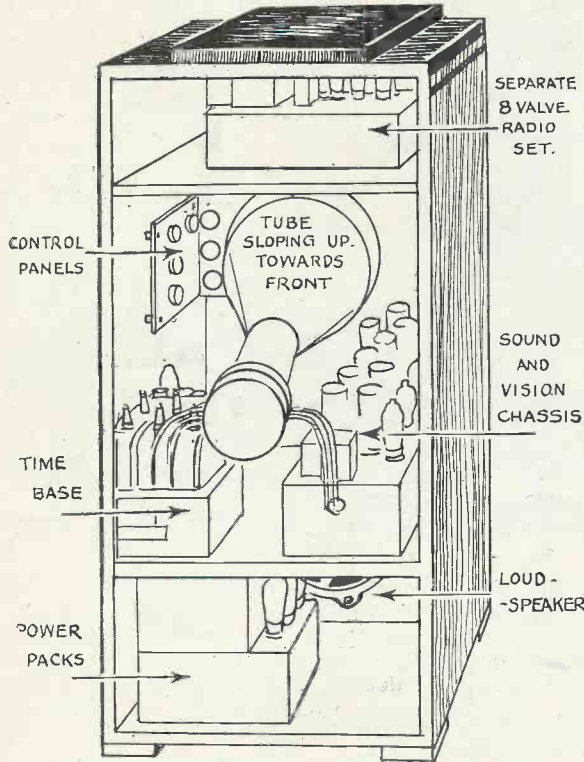

Above: The arrangement of the G.E.C. receiver which includes an all-wave set. The tube is placed comparatively low down in a sloping position, the time bases and sound and vision receivers being at either side.

Right: The tuning control of the Baird receiver is by means of a flexible cable which operates a worm wheel attached to the condenser spindle.

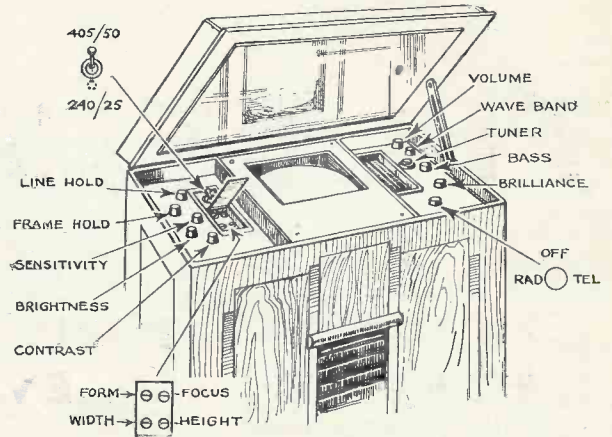
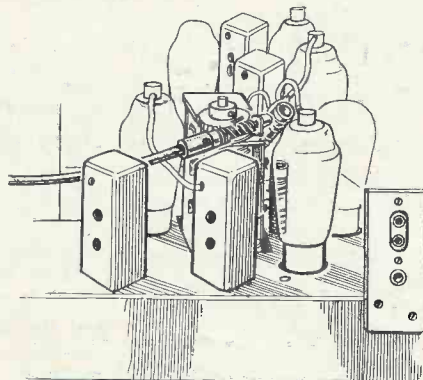

The controls of the Marconi-E.M.I. receiver are at either side of the end of the tube. Most of these are semi-permanent and do not require adjustment under ordinary conditions.

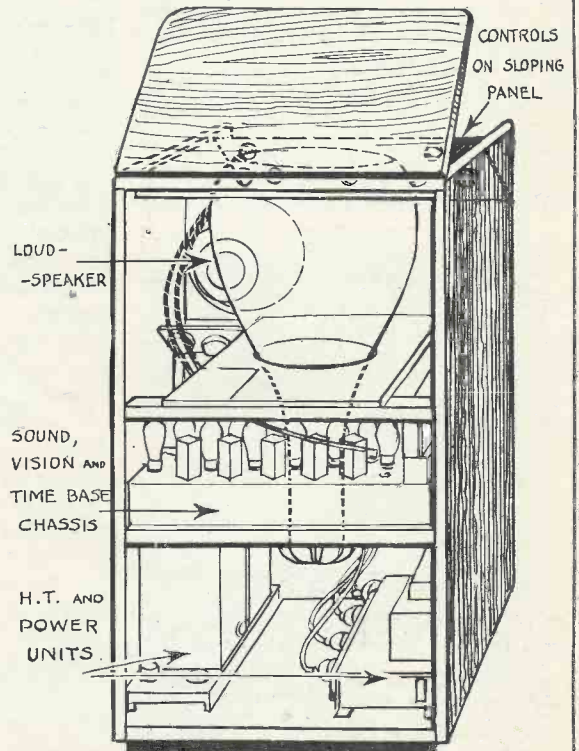

Above: The arrangements of the units of the Baird receiver seen from the back. One chassis is used for the sound and vision receivers and the time bases whilst the power packs are in a compartment below.

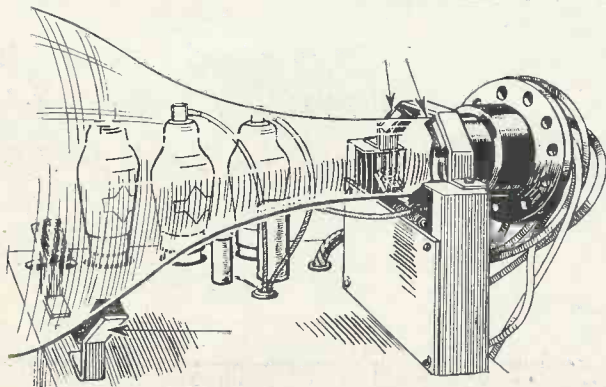

Left: The method of mounting the cathode-ray tube in the Cossor receiver. Sorbo rubber is used in a wooden framework.

BAIRD TELEVISION LTD.

PIONEERS & MANUFACTURERS OF ALL
TYPES OF TELEVISION EQUIPMENT

TELEVISOR

REGISTERED TRADE MARK

TELEVISION RECEIVERS WILL BE AVAILABLE IMMEDIATELY
THE REGULAR BROADCAST SERVICE COMMENCES
FROM THE B.B.C. STATION AT ALEXANDRA PALACE

FULL DETAILS OF THESE "TELEVISOR"
RECEIVING SETS SUPPLIED ON APPLICATION
TO BUSH RADIO Ltd., CHISWICK, W.4.

Head Office:
**GREENER HOUSE,
66, HAYMARKET,
LONDON, S.W.1.**

'Phone: Whitehall 5454

Studios and Laboratories:
**CRYSTAL PALACE,
ANERLEY ROAD,
LONDON, S.E. 19.**

'Phone: Sydenham 6030

RECENT TELEVISION DEVELOPMENTS

A RECORD OF PATENTS AND PROGRESS *Specially Compiled for this Journal*

Patentees:—Radio Akt D. S. Lowe :: A. D. Blumlein and J. D. McGee :: E. Traub
F. S. Turner :: Telefunken Ges Fur Drahtlose Telegraphie M.B.H.

Cathode-ray Tubes (Patent No. 446,635.)

The cathode C is surrounded by a negatively-charged cylinder to which the control grid G is attached. The electron stream is first focused by positively-charged anodes A, A₁ and

According to the invention the scanning stream is caused to bring the potential of the individual cells on the screen periodically to the same value as that of the cathode of the tube, so that directly each of the cells is discharged it ceases to be bombarded

picture being faced by a ring-shaped anode. The scanning ray then traverses the opposite face of the screen.—(A. D. Blumlein and J. D. McGee.)

Mirror Scanning System (Patent No. 448,238.)

Light from the lamp L passes through a polarising prism P, a Kerr cell K, a second prism P₁, and an aperture A on to one of the mirrors of a high-speed or line-scanning drum L. This drum carries nine facets and, in addition, is associated with five "stationary" reflectors S which have the effect of multiplying the effective number of scanning lines thrown on to the slow-moving or framing drum F. Thus each rotation of the drum L produces $9 \times 5 = 45$ scanning lines, so that a speed of 6,000 revolutions per minute is sufficient to produce 4,500 scanning lines per second. The object is to enable a mechanical scanning system to handle high-definition pictures without having to be rotated at an excessively high speed.—(E. Traub.)

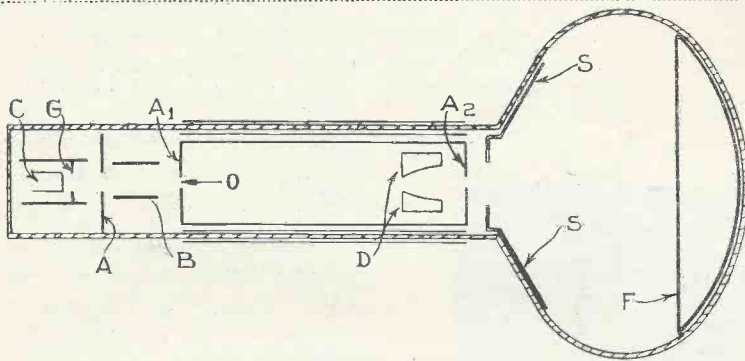

Cathode-ray tube for producing pictures of uniform density. Patent No. 446,635.

a negatively-charged cylinder B, so as to pass cleanly through the aperture O. It is again focused before reaching the fluorescent screen F by a less positive anode A₂ and a more positive anode A₃. The scanning electrodes are shown at D. A coating S serves to prevent the formation of charges in the inside walls of the bulb.

The arrangement is stated to produce television pictures having a uniform density and clear definition over their entire surface.—(Radio Akt. D. S. Loewe.)

Television Transmitters (Patent No. 446,661.)

The transmitter is of the Iconoscope type and comprises (a) a mosaic screen having a large number of small photo-electric cells, (b) means for projecting an optical image of the picture to be transmitted on the mosaic screen, (c) means for collecting the electrons emitted by the cells in quantity proportional to the respective light-and-shade values of various parts of the picture, and (d) an electron stream or cathode-ray for scanning the mosaic screen.

by the electron stream, and in this way is protected from damage. The mosaic screen may be double-sided, the side receiving the image of the

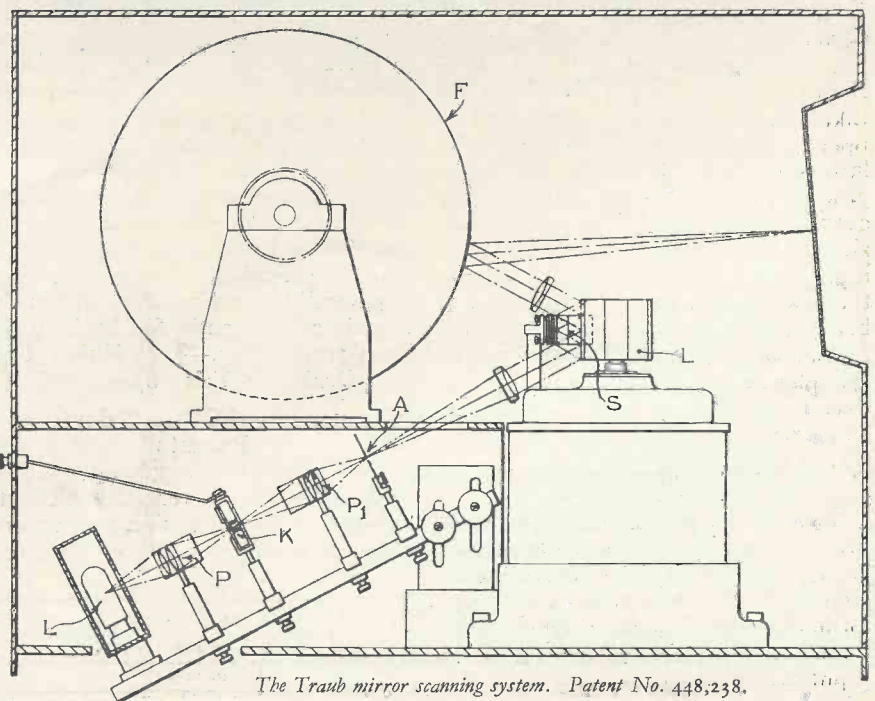

The Traub mirror scanning system. Patent No. 448,238.

Picture and Sound Systems

(Patent No. 448,648.)

Instead of using a filter circuit to separate the picture signals from the associated speech or music, advantage is taken of the so-called "aperture effect" to secure the desired result. For instance, if the scanning aperture is made to move across the screen at such a speed that it covers one complete cycle of a certain frequency in a distance equal to its own width, that frequency will have no perceptible effect on the screen. Accordingly if the sound signals are radiated on a selected carrier-wave, and the scanning speed is then adjusted so as to produce the aperture effect, the "sound" carrier can be fed into the picture receiver with-

frequency lower than the lowest side-band frequency, whilst the secondary winding is tuned slightly above the highest side-band frequency. Capacity effects between the coil windings and earth are compensated by using a cylindrical open core for the primary coil, and by dividing the secondary into two separate halves which are adjusted along the primary core until equal signal voltages are applied to the grids of each of the push-pull valves.—(Radio Akt. D. S. Loewe.)

"Outside" Transmissions

(Patent No. 450,303.)

When transmitting pictures of outdoor events difficulties may arise in synchronising the local "pick-up" device (or television "camera") with

of the synchronising impulses.—(A. D. Blumlein.)

(Patent No. 448,113.)

Wide band amplifier, particularly for television, giving a straight-line response throughout.—(K o l s t e r-Brandes, Ltd., and C. W. Earp.)

(Patent No. 449,177.)

Combined cathode-ray tube and saw-toothed oscillation-generator.—(Marconi's Wireless Telegraph Co., Ltd., L. M. Myers; and R. Cadzow.)

(Patent No. 449,205.)

Method of separating the two types of signal in a receiver designed to handle combined sound and picture programmes.—(General Electric Co., Ltd., D. C. Epsley and G. C. Marris.)

(Patent No. 449,392.)

Method of manufacturing fluorescent screens for cathode-ray tubes.—(A. Carpmael.)

(Patent No. 449,466.)

Removing the carrier wave component in a television receiver by means of a push-pull rectifier.—(Radio Akt. D. S. Loewe.)

(Patent No. 449,743.)

Time-base circuit for scanning and synchronising television signals.—(Hazelton Corporation.)

(Patent No. 449,822.)

Cutting out "harmonics" of the supply frequency, and similar disturbances, from a television receiver.—(General Electric Co., Ltd., and D. C. Epsley.)

(Patent No. 449,824.)

Television system in which the picture is produced by applying electric charges to an insulating surface by means of an electron beam controlled by the signals.—(Egyesult Izzolampa E. S. Villa-Mossagi.)

(Patent No. 450,413.)

Television "pick-up" installation in which a number of photo-electric cells are arranged in different positions and are brought alternately into action.—(Marconi's Wireless Telegraph Co., Ltd., and H. M. Dowsett.)

Television Lectures

On each Friday evening, commencing September 25, Morley College, Westminster, S.E.1, the educational centre for working men and women, is providing television lectures given by Mr. J. J. Denton, Fellow of the Institute of Electronics and the hon. secretary of the Television Society.

The lectures are in two courses, elementary and advanced; they are given at 7-8.30 p.m., and 8.30-10 p.m. respectively and can be attended at a moderate fee.

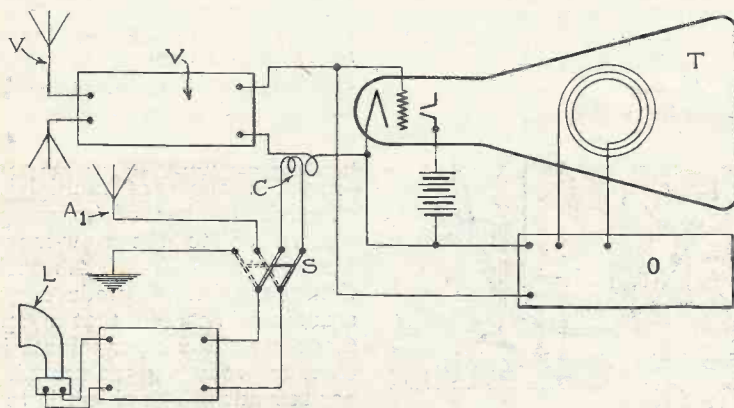

Combined picture and sound system. Patent No. 448,648.

out giving rise to any visible effect on the screen.

At the receiving end the "mixed" signals are received on an aerial A and are amplified up at V. A sufficient transfer of speech signal-energy takes place across the coupling C to operate the loud-speaker L; or the latter can be operated by the direct pick-up from an aerial A1 by moving over the switch S. The rest of the signals are applied directly to the input circuit of the cathode-ray tube, the saw-toothed scanning oscillator O being so adjusted that the "speech" carrier-wave is rendered harmless and the picture signals alone are reproduced on the screen T.—(F. S. Turner.)

Push-pull Detectors

(Patent No. 450,241.)

Two valves arranged in push-pull are used to rectify television signals so as to remove any carrier-wave component that may tend to introduce an undesirable "grain" effect in the picture. The primary winding of the input transformer is tuned to a fre-

quency lower than the lowest side-band frequency, whilst the secondary winding is tuned slightly above the highest side-band frequency. Capacity effects between the coil windings and earth are compensated by using a cylindrical open core for the primary coil, and by dividing the secondary into two separate halves which are adjusted along the primary core until equal signal voltages are applied to the grids of each of the push-pull valves.—(Radio Akt. D. S. Loewe.)

Accordingly the required synchronising signals are first radiated from the distant transmitter and are picked up by a small receiver at the local position. Here, after amplification, they are applied to the television "camera" and are incorporated in the signals subsequently fed back to the main transmitter.—(Telefunken Ges. Fur Drahtlose Telegraphie M.B.H.)

Summary of Other Television Patents

(Patent No. 446,663.)

Television receiver designed to eliminate the "flashing" caused either by interference or by the action

Our Policy
"The Development of
Television."

OCTOBER, 1936

A CRITICISM OF THE RADIOLYMPIA TELEVISION PROGRAMMES

WHEN the B.B.C.'s regular television programmes are in full operation we hope to present in TELEVISION AND SHORT-WAVE WORLD continuous constructive criticism of the programme builders' efforts.

It is premature, at present, to begin this friendly criticism merely on the strength of the programmes which were broadcast from Alexandra Palace to Radiolympia, for we all know that those particular transmissions were necessarily of a very preliminary and immature character.

Bearing in mind the fact that the apparatus had not long been available and working, and that Radiolympia arrangements were decided upon at the last minute, it would be unfair to the B.B.C.'s staff to expect, on that occasion, anything like the perfection of detail in the programmes which no doubt will be apparent when the regular service begins.

The following notes have been written, therefore, with a full appreciation of the many difficulties which the B.B.C. had to face, and in the hope that they may be of some small help to the B.B.C. in devising their programmes and studio arrangements in the near future.

It is understood that Mr. Gerald Cock, the B.B.C.'s Director of Television, was extremely anxious to hear and collate the reaction of viewers to his Radiolympia programmes, and as I looked in to the transmission altogether six times, I think I am able to give a fairly accurate impression which may be considered to be that of the "man-in-the-street."

Scenic Television

The possibilities of the wonderful Marconi-E.M.I. Emitron camera were made very evident by the panoramic view televised from the balcony at Alexandra Palace. The capabilities of the apparatus with films was well demonstrated, as also were the possibilities of studio performances.

Perhaps a better idea of the outside television programmes which now will be easily possible might have been more effectively conveyed to the general public if a view had been televised of a rider on a horse or some-

thing of that sort, from which the imagination would easily pass to the obvious possibilities of outside television broadcasts. By merely showing us the panoramic view from the balcony, I am afraid many people would not imagine the immense possibilities this foreshadows.

Choice of Matter

So far as the choice of films was concerned, I was not so happy. The short extracts from the new films were good and intriguing, but the two films about book-making and the Post Office seemed to me to be quite unsuitable for the purpose.

The book-making film anyway was not frightfully interesting as a sub-

ject, and as televised was far too long. It could conveniently have been cut to about one-fifth of the length, and then possibly might have made a useful interlude.

these were singularly well chosen. Titian-haired Helen McKay crooned effectively; Pogo, the wonder horse, was very amusing; the Three Admirals did their stuff well; but, in my opinion, the two dancers, Chilton and Thomas, easily were the best.

One item obviously was missing in this variety ensemble, and that was a good close-up comedian.

If the bill had been strengthened by the inclusion of, say, a five minutes' performance by a comedian of the George Robey or Leonard Henry type, the bill would have been exceedingly strong. It is difficult to understand why this was not done, for in entertainment matters, as we all know, nothing succeeds like a smile—even on the television screen.



A remarkable snap of The Three Admirals being televised at "Ally Pally."

I have suggested that it is a little too early to criticise the detail of presentation, because Mr. D. H. Munro, the Productions Manager at Alexandra Palace, obviously has not had time to perfect detail. One or two matters stood out a mile, however.

One was that Miss Helen McKay's dress definitely was unsuitable. As she appeared mostly as a close-up, it seemed to me that some contrast was wanted between her dress and her flesh. If, instead of wearing a white dress, she had worn, say, a black velvet one, there would have been a definite contrast between her white neck and shoulders and her dress, which would have made a much more pleasing picture on the screen. I noticed that one musical paper suggested she

The Variety Performances

Coming now to the variety artists,

(Continued in 3rd col. of page 570)

THE BAIRD ELECTRON MULTIPLIER

By V. H. Jones of Baird Television Ltd.

This article is the conclusion of that on the Baird Electron Camera published last month and explains the association of the electron multiplier with the electron-image camera

“ELECTRON MULTIPLIER” is the term used to describe various devices which take advantage of the property of certain substances of emitting an increased number of electrons on being bombarded with primary electrons having suitable potentials. This is the effect known as secondary emission.

It has been found that these devices can be constructed to give enormously high gains when used as



The racks containing the scan generators line amplifiers, synchronising generators and monitor tubes.

amplifiers, and that they will also reproduce signals of a much smaller order than can be reproduced with a normal valve amplifier. A device of this type has been developed to increase the minute signals resulting from the scanned electron image, to a level such that it may be amplified by a normal valve amplifier. This multiplier is built in the image tube, being interposed between the aperture and target or collector electrode, and the current passing through the aperture is amplified several hundred times before being collected on the target electrode.

The physical dimensions of this multiplier are very small. It is stable in operation, and if properly used will last practically indefinitely. The signal circuit after passing through the multiplier is now of sufficient amplitude to be dealt with by a normal valve amplifier.

The waveform and other characteristics of the signal will, of course, vary with the type and speed of the scanning used. Where a 240-line 25-frame scanning system is used (this is one of the standards used at the London Television Station), the smallest detail that it will be possible to resolve will be an area on the image

about equal in area to the aperture (this is known as the elemental or picture point size). The waveform generated when the aperture crosses this area will be a transient occurring in about 0.5 of a microsecond.

For a faithful representation of the signal, the response of the amplifiers will need to be as uniform as possible up to a frequency having a periodicity of about this order; also, for reasons dealt with fully elsewhere, it is necessary that there should be no great phase distortion. This is particularly important at the lower frequency. The phase change at the frequency of the frame scanning speed should be of a very small order, less than 1 degree, and this condition could be maintained down to frequencies with only a fraction of this. In general, it is necessary that the following minimum performance should be fulfilled by the amplifiers:—

- (1) That the gain of these amplifiers should be reasonably uniform from frame frequency to picture point frequency, this is about 2 megacycles for a 240-line 25-frame scanning speed.
- (2) That the phase distortion should be negligible at the lower frequency and only a small order of the higher frequency.
- (3) That they should be stable in operation, and not liable to change over long periods of operation.

The type of amplifier developed for use with this equipment has, for reasons of economy, been built for mains operation. A further feature of interest is that a form of variable high frequency compensation has been developed with a view to facilitating rapid changes from one standard of scanning to another.

In the design and construction of this apparatus great attention has been devoted to ease of operation, both with regard to the constancy of the electrical apparatus and to the practical operation of the camera during programmes.

The complete camera head, without the outer cover, consists of scanning and focusing coils and a head amplifier, etc., all mounted on a chassis which can be easily placed in the aluminium case, and even with its outer casing it is considerably smaller and lighter than most film cameras. The cable carrying the picture line and various supplies and scanning currents to the camera has been specially developed and is light and very flexible. It is usual to have about 50 ft. of this cable from the camera to the racks and connected to additional lengths as desired.

The later amplifiers and other units are built in normal rack form following closely standard practice. The whole equipment for operating two electron cameras is housed in four racks (Fig. 2). Rack 1 consists of the amplifiers and D.C. supply units of the camera, and is the “control” for the unit. Rack 2 has the power supplies and other subsidiary apparatus on it. Racks 3 and 4 are the scanning and synchronising units, respectively.

The operation and use of the electron camera under programme conditions, is extremely simple and follows quite closely on talking film camera technique. In

(Continued on page 605).

STUDIO & SCREEN

A MONTHLY CAUSERIE
on
Television Personalities
and Topics

by K. P. HUNT
Editor of "Radio Pictorial"

A GREAT calm has descended upon Alexandra Palace after the rush and tear of Radiolympia week. Like the "morning after the night before," but it is lasting for several weeks instead of only a morning!

It is a great pity, in many respects, that these preliminary demonstrations of the B.B.C.'s high-definition pictures were decided upon in such a hurry: no one had time to make really adequate preparations. But on the other hand, there can be little doubt, by thus pushing things forward so as to take advantage of the widespread interest focused upon Radiolympia, the new television has begun with a fillip which otherwise it probably would never have received.

* * *

I said that a calm had descended upon "Ally Pally": but it is not for long. At the moment of writing the production staff is frightfully busy pooling ideas for the rehearsal programmes which, if the engineers' plans do not miscarry, are scheduled to go out on the air as from October 1.

Cecil Madden who, as I have previously mentioned in these notes, is one of the producers working under Mr. D. H. Munro, the Productions Manager, is acting as a sort of general clearing house for these ideas.

The programmes, which are to begin on or about October 1, have been termed rehearsal programmes merely to distinguish them from the regular programmes which, according to present estimates, are likely to be in operation about December 1. These rehearsal programmes will last about one hour and will be broadcast daily and, I am told, listeners and lookers will be reminded at ten minute intervals that the programmes are purely of a rehearsal and experimental nature.

This will be fairly evident in any case, for individual items may fre-

quently be stopped and repeated, and various alterations made with a view of testing studio placement, lighting, make-up and all the other niceties of presentation which must be worked out and systemised before the inauguration of routine programmes.

* * *

One of the incidental benefits of this month of rehearsal programmes—and one which will be greatly appreciated—is that it will give television set manufacturers and wireless traders a much-needed breathing space.

It was obvious that the Radiolympia transmissions did not receive anything like the publicity they might have achieved, simply on account of the fact that so few television receivers, apart from the official ones at Radiolympia, were available. So far as I know, the only others by means of which the programmes could be seen were at the Science Museum at Kensington, and Waterloo Station and, of course, the various makers.

During this rehearsal month, then, manufacturers will have facilities for testing receivers, and the various firms intending to open public looking-in rooms will have time to prepare them and test the capabilities of their equipment.

No one will dispute, therefore, that it is a wise arrangement to have a month, so to speak, of marking time, but during this interval to provide continuous television transmissions. In this way, no lengthy break will intervene between Radiolympia and the commencement of the programmes proper.

The actual hour of these rehearsal programmes has not been announced at the time of writing, but I am told they will probably be broadcast from 3.0 p.m. to 4.0 p.m. each day.

* * *

It is now practically certain that

no interval will elapse between this period of very experimental rehearsal programmes and the subsequent regular programmes. For all practical purposes, therefore, we may say there will be continuous television as from October 1.

It is also uncertain, at the moment, exactly how long this period of rehearsal programmes will last. I have mentioned a month merely in a general sense, but I am told it may be possible to terminate them in less than three weeks. The present plan, I understand, is to follow this period by, say, a month or five weeks of what may be called "dress rehearsals" for the regular programmes.

These dress rehearsal programmes will probably be transmitted twice a day—perhaps an hour in the afternoon and an hour at night.

In these dress rehearsal programmes, an attempt will be made to present the new service exactly as it will be when the regular programmes begin officially, but, at the same time, lookers will constantly be asked to be forebearing and to remember they are still merely rehearsals. When this period is over, the regular programmes will begin.

It is outside my province in these notes to deal with technical matters, but I may mention in passing that considerable activity has been evident on the engineering side at Alexandra Palace ever since Radiolympia closed.

Test transmissions have been on the air almost daily, and anyone strolling along the terrace at Alexandra Palace during the last few days doubtless would have spotted the auxiliary aerial of the dipole type which was erected by the Baird Company for experimental purposes and, of course, is temporary only.

I have been to some pains to find out exactly what will be the nature of the rehearsal programmes which will begin almost as soon as these notes are in print, if not before.

PLANNING FUTURE PROGRAMMES

It has been hinted to me that the programmes will consist principally of general interest features, and that some quite daring experiments will be made.

I was told, for instance, that Mr. Cock himself is very anxious to put the new television apparatus to extremely stringent tests during this period, in order to decide exactly what can and what cannot be done, and that, in consequence, we may expect some notably ambitious outdoor shots to be made.

"It is improbable," I was told, "that we shall go slowly in the matter of exploiting to the full the new apparatus."

Mr. Cock, or "D. Tel," as he is always called at "Ally Pally," did not seem to show any outward signs of the great mental stress which he must have been experiencing during Radiolympia week, but I do happen to know that he was extremely keen to learn what the man-in-the-street thought about television.

He made several visits to Radiolympia and mixed among the crowds who were waiting to see the television demonstrations.

I spotted him on one occasion, moving incognito among the interested lookers who no doubt would have been greatly surprised had they known that the quiet man with the alert eyes and inscrutable face who was standing next to them was none other than the very man who had control of this new service.

* * *

Just at present, Mr. Cock is concentrating upon the many organisation details inseparable from the establishment of the new service. In this, he is being assisted by his able lieutenant, Leonard Schuster, who is known as "Tel Ex." He is responsible for the smooth working of the machine. He deals with organisation down to the smallest detail—even the arrangement of the B.B.C.'s 'bus service to and from the Palace.

I suppose the busiest man during Radiolympia week was D. H. Munro, the productions manager, for he worked like a Trojan, and was seldom out of the studios at all. Undoubtedly he was largely responsible for the great success of the transmissions.

He is already forging ahead with his new rehearsal programmes and,

at the time of writing this, already has planned out the first two weeks' programmes.

Miss Bligh, the other television hostess-announcer, was not seen during Radiolympia week and she is now in the Isle of Wight. I am told that the operation for appendicitis which she has just undergone proved to be much more serious than at first was anticipated, but that she hopes to be back at work towards the end of October in time for the beginning of the dress rehearsal month.

Another member of the "Ally Pally" staff who had a really busy time during Radiolympia and since then has still been frightfully busy, is Miss Mary Allan, the make-up expert. I discovered a few days ago, that three competitive make-up demonstrations had just been held at the Palace in order to determine to which firm should be given the contract for powder, paint and the other make-up requisites.

As readers of these notes already know, in the Baird intermediate film system the ordinary film technique is followed so far as make-up is concerned, and it has now been determined that the make-up most suitable for the Marconi-E.M.I. Emitron camera also is closely similar to that required in ordinary film technique. This discovery considerably simplifies television make-up problems.

These make-up tests at "Ally Pally" provided a tremendous amount of fun for the staff, for I hear that all sorts of people—typists, officeboys and even engineers—were recruited and put in front of the camera.

* * *

It is difficult to draw special attention to any one member of the staff at "Ally Pally" who contributed more than others to the success of the Radiolympia transmissions because, of course, it was the result of a co-operation of effort.

But it would be a pity not to point out that Cecil Lewis came through the ordeal with glowing colours when you remember that he had left announcing for ten years.

Rather remarkable, I thought it was, that he could just sit down in front of the microphone and describe those views of the surrounding country, taken in by the Emitron camera from the balcony, with the same clarity, interesting comments and quiet confidence which he always displayed in his early days with the B.B.C. In fact, the Radiolympia week showed that Cecil Lewis has lost none of his poise. Here is a man, I predict, who has a great future in this new sphere.

"A Criticism of Radiolympia Television programmes"

(Continued from page 567).

should have worn a high-necked dress.

In the early Radiolympia programmes I observed that what appeared to be the backcloths in the studio were badly arranged behind Miss Helen McKay. The effect at Radiolympia was that a piece of carpet had been hung up behind her: you could see the edges at each side, and the whole thing looked frightfully crude.

The other acts were well presented and the dancers in particular, I thought, got a very fine showing.

I will forebear any criticism of the make-up of the artists, as that would be unfair. Miss Allan, the television make-up expert, obviously has not yet had time to evolve a suitable technique. It will suffice for me to point out that the matter needs very complete attention, for the faces of the whole of the artists, so far as the light and shadow were concerned, came out extremely badly.

The televised pictures of Leslie Mitchell, the announcer, for instance, did not remotely do him justice, his eyes usually being dark shadows. Elizabeth Cowell, the announceress, suffered greatly in the same way. Whether this is entirely a question of make-up, or whether considerably more light is needed in the studio, I will not at present hazard an opinion but, no doubt, the problem is receiving careful study at Alexandra Palace.

K.P.H.

OUR POLICY
The Development
of
TELEVISION

TELEVISION WITHOUT MAINS SUPPLIES

By L. S. KAYSIE

A Scheme for "Portable" Television by the Loewe Company

MOBILE television sets will, of course, be used for transmitting topical or other "outside" events, once the new high-definition service is in full swing. But a portable television receiver is quite another proposition, particularly as ap-

ponents can be reduced without much trouble, but the L.T. and H.T. supply is not so easily disposed of. In a cathode-ray receiver, for instance, the provision of the H.T. supply presents quite a problem when operating at a distance from the electric supply mains.

One way out of the difficulty is suggested by the vibrating-contact type of eliminator which supplies the O.T. for a car radio set.

A low-voltage battery is used to feed the primary coil of a transformer, and the primary current is rapidly interrupted by a make-and-break contact. The intermittent current so produced is then stepped-up to any value required by ordinary transformer action across the primary and secondary windings. The secondary circuit includes a second make-and-break contact, which is synchronised with the first in order to convert the A.C. back into D.C., and a smoothing circuit is added to filter out any ripples.

A high-tension supply-unit of this kind is illustrated in Fig. 1, where the vibrating armature A passes a low-tension current first in one direction and then in the other through the primary winding of the transformer T. The same armature is then used as a mechanical "commutator" to rectify the H.T. alternating current at the points C, C₁ in the secondary circuit. A smooth H.T. voltage of practically any desired value—depending on the step-up ratio of the transformer T—is thus made available across the output terminals of the smoothing circuit.

small motor from the L.T. accumulator. The construction of the drum is shown in greater detail in Fig. 2A, from which it will be seen that the outer surface consists of a row of insulated contacts C, equal in number to the number of scanning lines in the picture to be received. Each of the contacts is insulated from its neighbour, but they are all separately

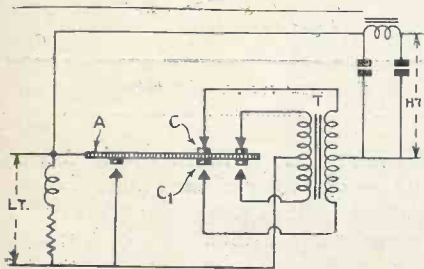

Fig. 1.—Vibrating contact H.T. supply unit.

plied to an outfit which is intended to be carried about out of doors.

Although perhaps a little in advance of its time, the idea has already been seriously put forward, both in connection with police patrol work—in which no doubt the set

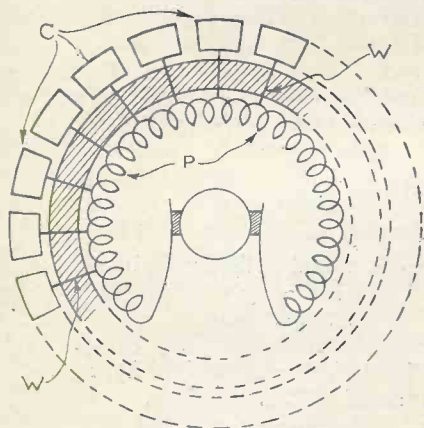

Fig. 2a.—Details of the framing drum.

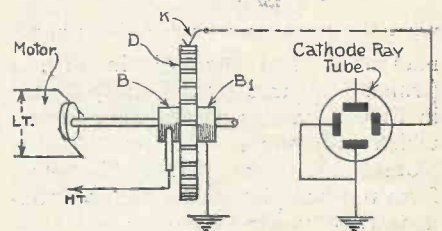

Fig. 2.—Generating the "frame" scanning voltage.

connected through short radial leads W to a coil P of high-resistance wire arranged around the inside of the drum.

As shown in Fig. 2, this wire is shunted across part of the H.T. supply through brushes B, B₁ on the motor shaft, so that it forms a potentiometer which is, in effect, tapped off by the leads W at equal distances along its length to the circle of contacts C on the outside of the disc. The contacts therefore carry a pro-

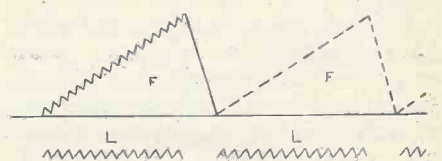

Fig. 3.—Saw-toothed scanning oscillations.

Producing Saw-toothed Voltages

The next problem in a portable television set is to produce the "saw-toothed" voltages required for the line and frame scanning electrodes of the cathode-ray tube. Fig. 2 shows how this has been tackled by the German firm of D. S. Loewe.

Taking the "framing" frequency first, it is derived from a commutator disc D, Fig. 2, which is driven by a

gressively-increasing voltage, which is collected by a wiper arm K and fed to the "framing" electrodes of the cathode-ray tube, Fig. 2.

The resulting saw-toothed scanning voltage has the shape shown at F in Fig. 3. Starting from zero, the voltage received by the wiper K increases in short steps as it passes from contact to contact until it reaches

would be normally installed in a motor car—as well as for military service in the field.

The chief difficulty with a portable television receiver is to discover suitable ways and means of providing the necessary operating-voltages. The size and weight of most of the circuit

maximum. It then drops rapidly back to zero as the wiper passes over the high-potential end of the wire P, and so produces the required "fly-back" motion of the cathode-ray. Immediately afterwards the voltage starts to build up again, and so the process is repeated.

The line-scanning voltages are produced in an equally ingenious

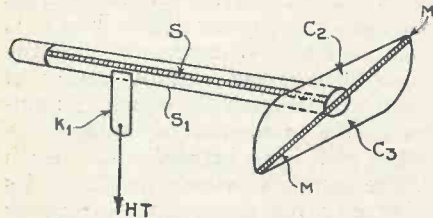

Fig. 4a.—Showing the shape of rotating condenser plate.

ately connected through split commutator sleeves S, S1 and a wiper arm K1 to a part of the H.T. supply.

A screening member P, Figs. 4 and 4B, is placed between the fixed and rotating plates, so that the effective capacity of the combination, at any moment, is determined by the area of the unscreened part of the

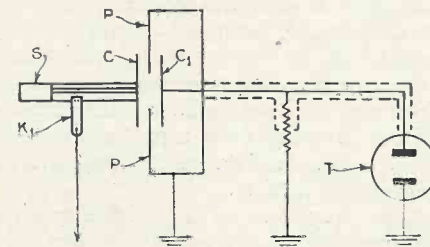

Fig. 4.—Producing the line scanning voltage.

C1 which, in turn, passes it on to the cathode-ray tube T.

The voltage rises as the unscreened area of the half-plate C3 increases, until it reaches a maximum. At this moment the wiper arm K1 passes on to the insulating strip, Fig. 4A, between the two conducting

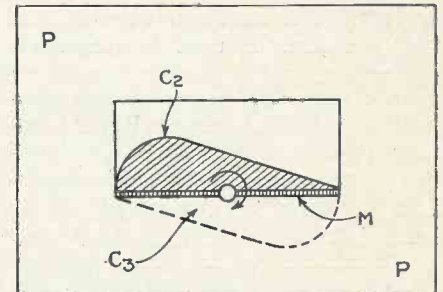

Fig. 4b.—How the scanning voltage is varied.

manner. The shaft S, in Fig. 4 (which is geared to the shaft shown in Fig. 2) carries a rotating plate C, which is mounted close to a fixed plate C1, so that the two in effect form the two plates of a variable condenser. The rotating plate C has the shape shown in Fig. 4A. It is divided into two equal halves C2, C3, which are insulated from each other along the line M, M and are separ-

rotating condenser-plate. In Fig. 4B, for instance, the capacity is at a maximum because the full area of the upper half-plate C2 is unscreened.

Starting, say, from the position shown in Fig. 4B, the edge of the lower plate C3 is beginning to rise above the screen, and since it is connected through the wiper K1 and sleeve S1 with the positive H.T., it induces a charge on the fixed plate

sleeves S, S1, so that there is now no charge on either of the plates C2, C3, and the voltage drops at once to zero. Immediately afterwards it starts to rise, as the half-plate C2 comes again into action, and increases to a maximum as before. And so the process goes on, producing a saw-toothed line-scanning voltage of the form shown at L-L in Fig. 3.

MEASURING UP TO 3,000 VOLTS WITH A HOME-MADE METER

By A. H. Berry, M.Sc.

This article describes the construction of an electrostatic voltmeter suitable for measuring up to three thousand volts. It will be found particularly useful for the amateur who is experimenting with cathode-ray apparatus.

WHEN a cathode-ray tube is used for television very high voltages, up to 3,000 volts, have generally to be used. Now every serious experimenter knows full well that without measurement of each variable quantity met with in an experiment or series of experiments, little real progress is possible; hence it becomes necessary when using a cathode-ray tube to be able to measure, at any rate approximately, voltages of the order mentioned.

A cheap voltmeter of the ordinary current type cannot be used, for it is essential that the current consumed be very small because the current generally available from the high-voltage transformer is only a few

milliamps. If this were taken by the voltmeter, the tube itself would be starved; and both tube and voltmeter must, of course, be in circuit together if the behaviour of the former under working conditions is to be observed.

A high-pressure electrostatic voltmeter which takes no current is an expensive instrument, but with a little care in calibration the gold-leaf electroscope can be made to serve the purpose very well, and will be found serviceable for both continuous and alternating current circuits. The constructional details which follow can, and no doubt will, be modified by the experimenter, but it is recommended that the dimensions given be not changed much.

Materials Required

- Sheet metal cylinder 2½ ins. dia and 1½ ins. long with two well-fitting lids. (A portion of a canister can be conveniently used).
- Piece of ebonite 2½ ins. by 1½ ins.
- 1 small 2 B.A. terminal.
- 1, 2 B.A. screw and nut.
- 1, 2 B.A. terminal with shank 2 ins. long, or length of 2 B.A. screwed rod 2½ ins. long, and 2, 2 B.A. nuts and washers.
- Dutch metal (obtainable at any scientific apparatus dealers') or gold-leaf.
- 2 circular pieces of glass or clear, stout celluloid, 2½ ins. dia.
- Small piece of mirror.

CALIBRATING A HOME-MADE METER

The cylinder has a hole at A, Fig. 1, $\frac{1}{2}$ in. diameter, and holes at B and C $\frac{3}{16}$ in. diameter. There is no need to make the hole at A very smooth, in fact a rough-edged hole is an advantage. The two lids have holes made in them leaving a rim about $\frac{1}{8}$ in. all round, and the pieces of glass or celluloid after having been cut to fit inside the lids are placed

Dutch metal is imitation gold-leaf; because of its thinness care is necessary in its manipulation. Place a sheet between two pieces of ordinary writing paper, and cut through both paper and leaf with a pair of sharp scissors. See that both paper and scissors are perfectly free from grease. Prepare a strip about $1\frac{1}{4}$ ins. long and $\frac{1}{8}$ in. wide, moisten the rod

the voltage applied and plotting a graph of volts against deflection of the leaf. When reading the deflection the leaf must always cover its image in the mirror or serious parallax errors will be introduced. If a high-range voltmeter cannot be borrowed, high-tension batteries can be connected in series and the graph plotted as before, the voltage of each cell being taken as $1\frac{1}{2}$ for dry cells and 2 for accumulators. Very great care indeed is necessary when making connections for high-voltage tests, even if the source of supply be only small-sized batteries, a current of three milliamperes through the body is sufficient to cause death, so wear a pair of good-quality rubber gloves when making any adjustments whatever to any high-voltage system.

Difficulty will no doubt be experienced in obtaining H.T. batteries to read up to 3,000 volts, but the principle known as extrapolation can be made use of without introducing any serious errors. For example, in Fig. 2 points are only plotted up to 400 volts and the rest of the curve drawn freehand. If the calibration and drawing are carefully done the error at 3,000 volts need not be greater than two or three per cent. It may be an advantage because of this extrapolation to plot deflection squared against voltage, the graph will then be found to approximate more nearly to a straight line and this will make its accurate extension easier.

After calibrating in this way a scale reading voltages directly may be constructed from the graph and fixed to the instrument. The construction of this scale directly without plotting the graph is impracticable, firstly because of the danger, and secondly because it will be found that approaching the leaf with a pen or any other object at earth potential will cause it to deflect.

The sensitiveness of this simple electrostatic voltmeter can easily be varied by altering the length and thickness of the leaf. If thin real gold-leaf is used voltages of the order of 100 to 250 such as are made use of in modern mains receivers can be quite accurately read. Thin gold-leaf, however, is very troublesome to work with, and it is recommended that the services of a professional gilder or decorator be called in to cut and fix the leaf if such a relatively low-reading voltmeter is attempted.

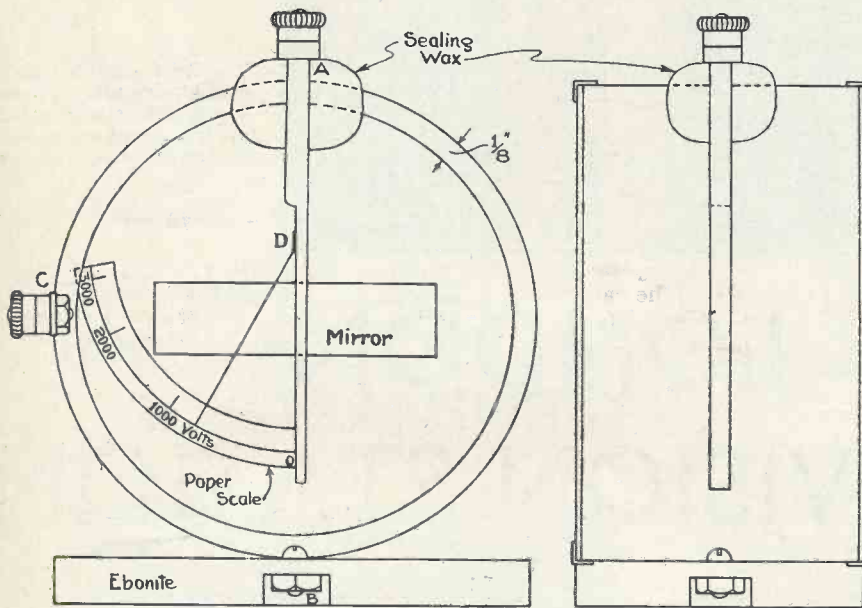

Fig. 1.—Front and side elevations of the electrostatic voltmeter showing details of construction.

in position. The piece of mirror is fixed to one of the pieces of celluloid with cement so that the reflecting surface is towards the inside of the voltmeter, and under the mirror a paper scale graduated in inches or degrees is fixed at the same time.

A length of about $1\frac{1}{4}$ ins. of the shank of the long terminal is next filed flat, and the terminal is then fixed in position with sealing wax. To make a firm joint it will be found necessary to heat both terminal and can, until the wax is just beginning to run over the surface of the metal. The whole assembly must be held with the pieces in the required relative positions until the wax is quite cold and hard.

Terminal C is now placed in position, and the voltmeter fixed to its ebonite board by the 2 B.A. screw. The hole in the ebonite must be deeply countersunk as shown, so that none of the metal of the screw or nut can touch the bench on which the instrument rests.

of the instrument for $\frac{1}{8}$ in. at the point D, pick up the leaf with a clean pair of tweezers and apply to the rod. It will be found to stick quite firmly in position with this simple fixative. Place the lids on the cylinder, and the voltmeter is ready for calibration.

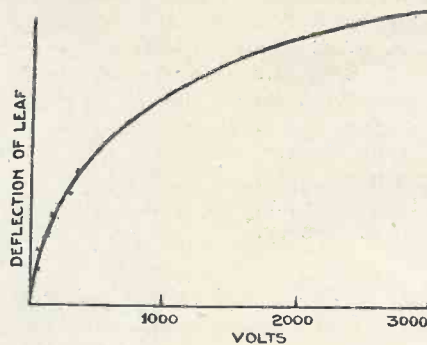

Fig. 2.—Graph showing how the meter is calibrated.

This operation is most easily carried out by connecting in parallel with a high-range voltmeter, varying



The Baird studio at Alexandra Palace with the intermediate film stanner on the left in a glass-fronted cubicle; the control room is above.

THE London television station stands on a hill in North London 306 feet above sea level. The actual premises are the south-eastern corner of the Alexandra Palace, a well-known North London pleasure resort. From the trustees of the Palace the B.B.C. has leased 31,840 sq. ft. of floor space, comprising three large halls on the ground floor, the rooms over them on the first floor, and the S.E. tower. A further area of 24,525 sq. ft., comprising the theatre and associated rooms has also been taken, but up to the present no use has been made of this portion.

The lower floor halls have been converted to the purpose of transmitter rooms, a film-viewing room, a restaurant and kitchen. The rooms on the first floor above have been converted into two large studios with control rooms and apparatus rooms separating them. Dressing rooms and make-up rooms for band and artists have been constructed, separated from the studios by a corridor. Adjoining these on the west side is a light well, separating the B.B.C. premises from the rest of the Palace. This has been used to form (a) in the basement, a boiler house for the heating system, which has been installed throughout the premises; (b) a floor at ground level for the preparation of scenery; and (c) another floor at first level for the storage of scenery.

Aerial Mast

The television mast is erected on top of the south-eastern tower. Its highest point is 300 ft. above the ground, the height of the steelwork above the brick tower being 215 ft. It is tapered for a height of 105 ft. above the tower and is square in section, the sides of

THE LONDON TELEVISION STATION

the square being 30 ft. at the bottom and 7 ft. at the top of the tapered portion. At this point, to suit the special design of aerials, the section changes from a 7 ft. square to an octagon 7 ft. from face to face, and

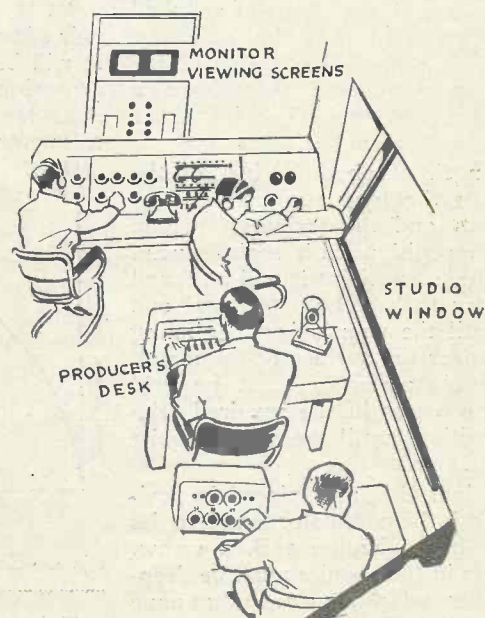

Sketch showing the arrangement of the control room for the Marconi-E.M.I. studio.

OCTOBER, 1936

maintains these dimensions up to the top of the mast. On account of exposure to the force of gales, special means have been adopted to transmit the loads to the brick tower. Four steel lattice girders, 30 ft. long and 7 ft. 6 ins. high, in the form of a square, were placed on top of the existing brick tower. The four legs of the mast were then bolted to the corners of this square, and each corner was then embedded in 17 tons of concrete. In addition to this, at each corner a heavy angle-shaped steel tie bar, 50 ft. long, was carried down inside each corner of the tower, and after being subjected to a tension of 30 tons was firmly connected with the brickwork of the tower with this pull still upon it.

Aerial System

Separate aerial systems are provided—one for vision and one for sound. Both systems are similar, each consisting of a number of aerial elements arranged round the mast, those for vision being above and those for sound beneath. Each aerial consists of eight push-

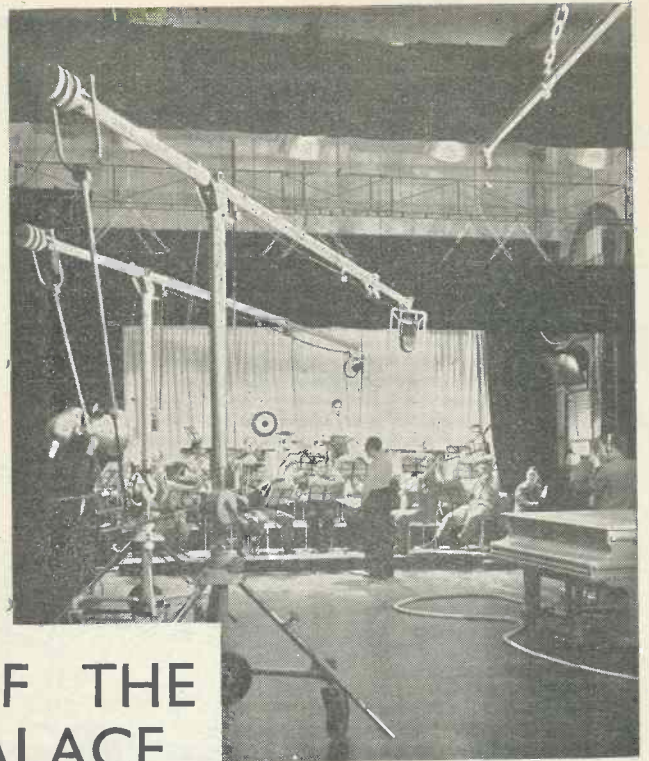

The Marconi-E.M.I. studio showing the Emitron camera (on right) transmitting an orchestra.

COMPLETE DETAILS OF THE B.B.C. ALEXANDRA PALACE TRANSMITTER



The Marconi-E.M.I. Emitron electron camera being used in the grounds of the Alexandra Palace.

pull end-fed vertical dipoles spaced equi-angularly round the mast, together with a similar set of dipoles used as reflectors to avoid induced currents in the mast structure and so increase the radiated field.

The aerials are connected to junction boxes, with which are associated a number of impedance-matching transformers to correct the aerial response. The aerial systems are connected to the transmitters by means of two 5 in. concentric feeders which pass down the mast and along to the transmitting rooms, a change-over switch being provided so that either the Baird or Marconi-E.M.I. vision transmitters can be connected to the vision aerial at will.

Power Supply

The power supply for the whole building is obtained from the mains of the North Metropolitan Electric Power Supply Company at 415 volts 50 cycles 3 phase, and is fed through a main oil-circuit-breaker and distribution switch-gear.

Aerial Power Rating

The sound transmitted is capable of operating over a band of frequencies from 35 to 50 mc/s, the working frequency being 41.5 mc/s, and the output power rating 3 Kw, at 90 per cent. peak modulation (Copenhagen rating). Owing to the different method and range of modulation adopted for the vision transmitters, the Copenhagen rating would have no meaning, and these transmitters are rated in terms of the instantaneous peak power which they will deliver to the aerial at

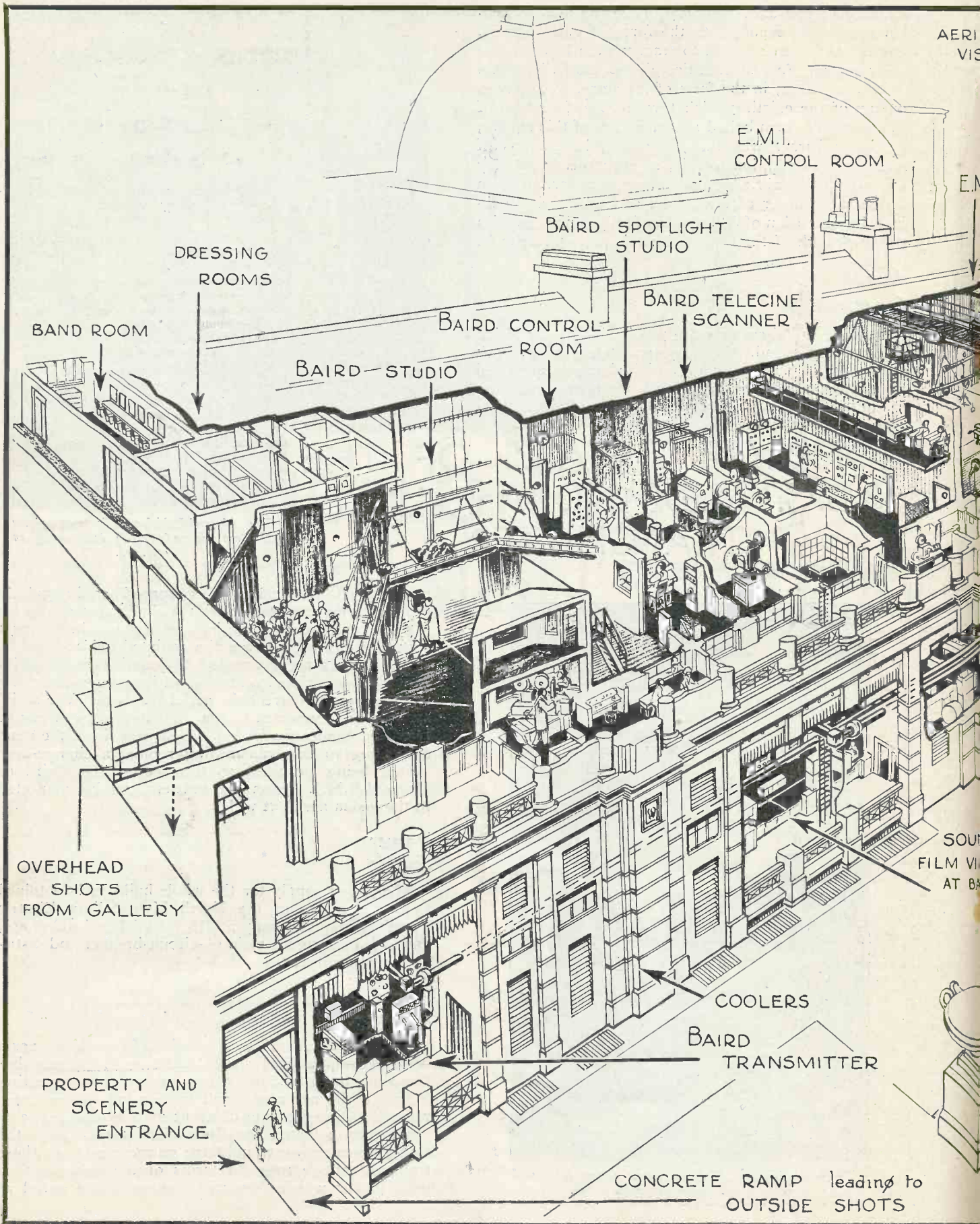

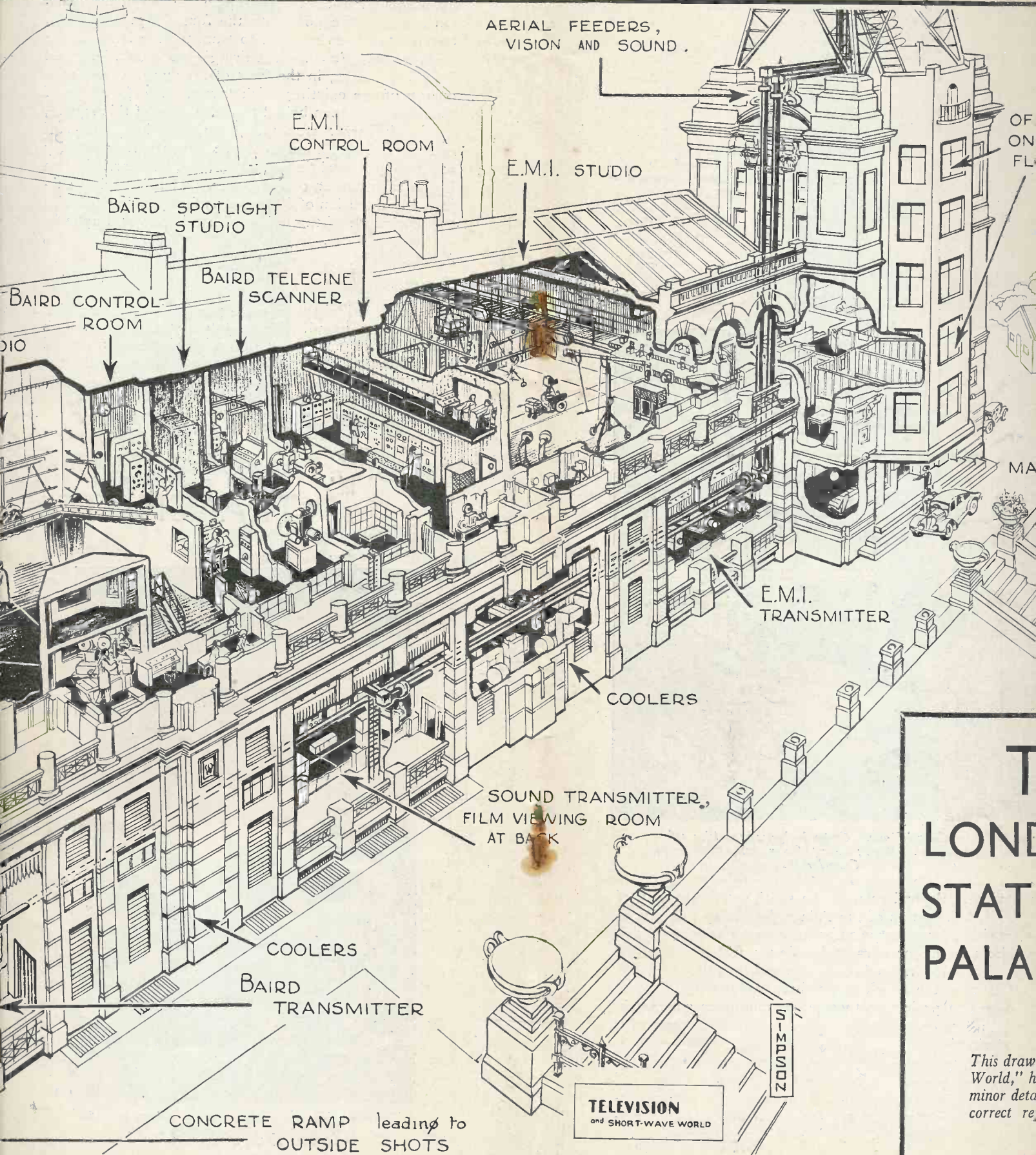

T
LOND
STAT
PALA

This draw
World," h
minor deta
correct re

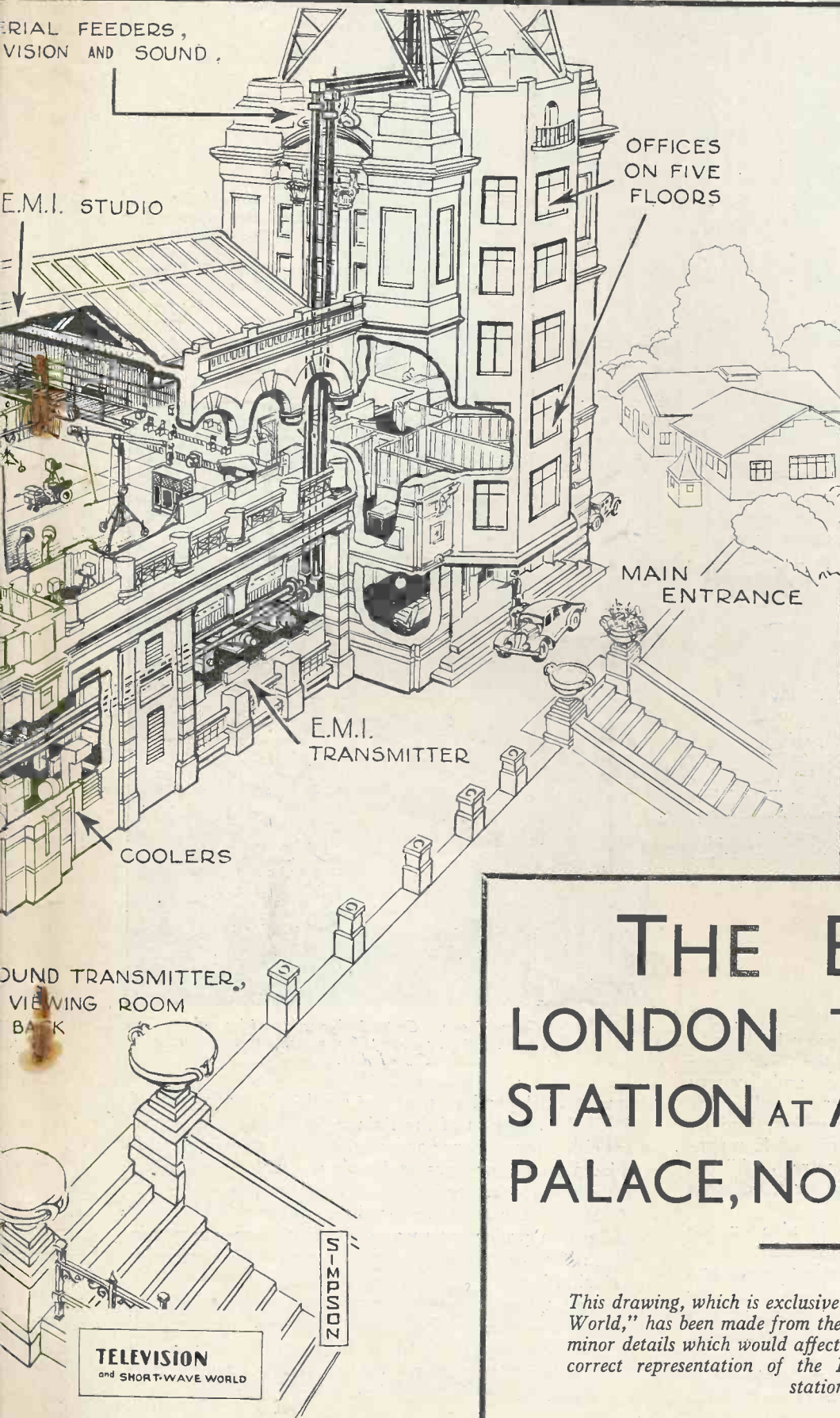

**DETAILS OF TRANSMISSIONS
FROM THE
B.B.C. TELEVISION STATION
AT ALEXANDRA PALACE**

The following is a summary of the arrangements made for the television transmissions from the Alexandra Palace :—

The Baird System will use 240 lines, sequential scanning, 25 pictures per second. Marconi-E. M. I. will use 405 lines, 25 pictures per second, interlaced scanning to give 50 frames per second, each of 202 1/2 lines. Receivers can be constructed capable of receiving both types of transmission without undue complicated adjustment. The format for both systems will be 4x3.

The vision signals with either system will be radiated on a frequency of 45 Mc/s (6.7 metres), and the associated sound signals will be radiated on a frequency of 41.5 Mc/s (7.2 metres). The power of the vision transmitters will be 17 kilowatt peak during periods of maximum modulation, while the sound transmitted will have a power of 3 kilowatt, 90 per cent. modulation, Copenhagen rating.

Direct television will be given by the Baird System by means of intermediate film and the image-dissector, while the Marconi-E. M. I. Company will use the Iconoscope camera (Emitron). Film transmissions will also be given, the Baird Company using mechanical scanning and Marconi-E. M. I. the Emitron.

Three programme periods are contemplated daily at :—3.0—4.0 p.m. 6.15—7.15 p.m. 9.30—10.30 p.m.

Programmes will be provided by one system at a time, the two systems working alternately week by week.

**THE B.B.C.
LONDON TELEVISION
STATION AT ALEXANDRA
PALACE, NORTH LONDON**

This drawing, which is exclusive to "Television and Short-wave World," has been made from the architect's plans and except for minor details which would affect the clarity of the picture is a correct representation of the London television transmitting station.

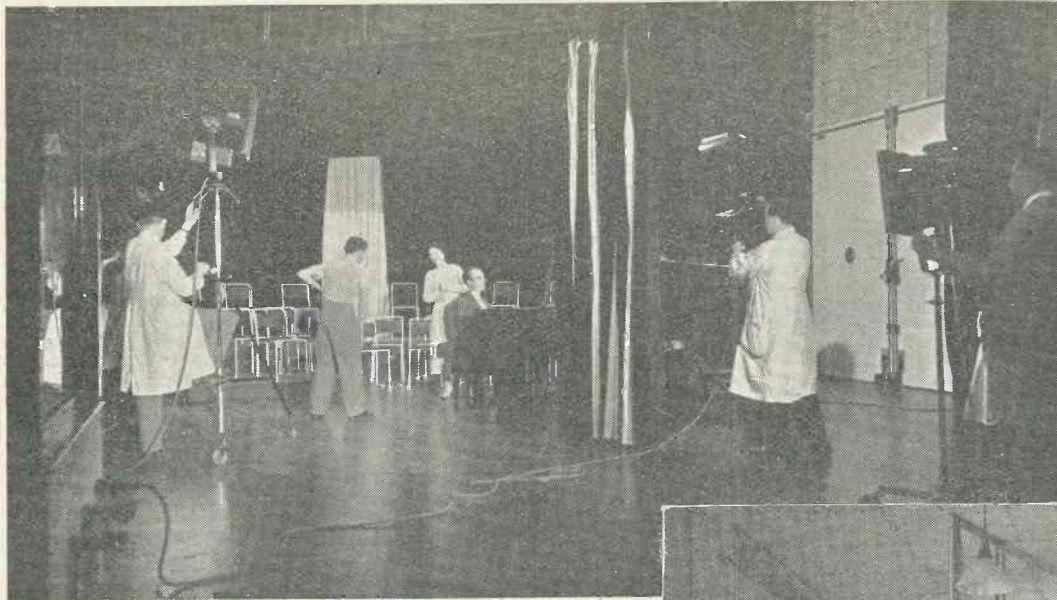

Another view of the Baird studio showing the arrangements for lighting.

100 per cent. modulation—about 17 Kw. On this basis, for comparison purposes, the sound transmitter would deliver to the aerial an instantaneous peak power at 100 per cent. modulation of 12 kW.

Three Transmitters

In accordance with the recommendations of the Television Advisory Committee appointed to consider the development of television in Great Britain, provision has been made for alternate experimental transmission by the systems developed by the Baird Television Company and the Marconi-E.M.I. Television Company, respectively. Each company has provided a complete television system, including both vision and sound pick-up apparatus and the television transmitter itself. The B.B.C. has been responsible for the sound transmitter and its associated aerial

The Transmitter Floor

The entrance hall is at the base of the tower, and facing it is the main door to the stairway leading to the ground floor corridor which houses the three transmitters, projection theatre, restaurant and scenery productions shop. Nearest to the entrance hall is the Marconi-E.M.I. television transmitter which, like its Baird equivalent, operates on a frequency of 45 megacycles per second (wavelength: 6.67 metres). All the apparatus at the station is finished in grey cellulose and chromium.

The sound transmitter hall, which is also on the ground floor, accommodates an ultra-short wave installation of orthodox design for radiating speech and music accompanying the vision signals of both the Baird and Marconi-E.M.I. systems. Its operating frequency is 41.5 megacycles per second (wavelength: 7.23 metres).

The Baird transmitter hall, with its generators and amplification stages, is at the south-west end of the



Baird Control Room. Centre background: Vision monitoring panel. Right: Amplifier racks. Foreground: Control desk.

corridor. Beyond this, at the south-west extremity of the B.B.C. section of the Palace, is a large area intended either for scenery construction or for televising such objects as motor cars and animals which cannot be brought into the studio or televised outside.

Between the sound transmitter and the Baird plant is the film projection theatre, or miniature cinema, in which film excerpts can be selected and timed for inclusion in the transmissions.

Another feature is a sloping runway down which the television camera can be moved to a concrete "apron," of approximately 1,700 sq. ft. area, on the terrace outside, forming a platform for televising open-air performances or special experimental programmes.

Studios

The two main studios, one for use with each of the television systems, are 70 ft. by 30 ft. by 25 ft. high. Acoustically, the studios are rather more "dead" than is general practice for sound broadcasting, since the introduction of scenery necessary for television will, in effect, control the acoustic characteristics.

The walls of the studios are covered entirely with sheets of asbestos compound which has a high degree of sound absorption. As this material has a rather rough surface, it is covered up to about 10 ft. from the floor with a protective fabric which is designed not to affect the sound absorbing properties of the compound. The ceilings of the studios are treated with building board and the floors covered with black linoleum.

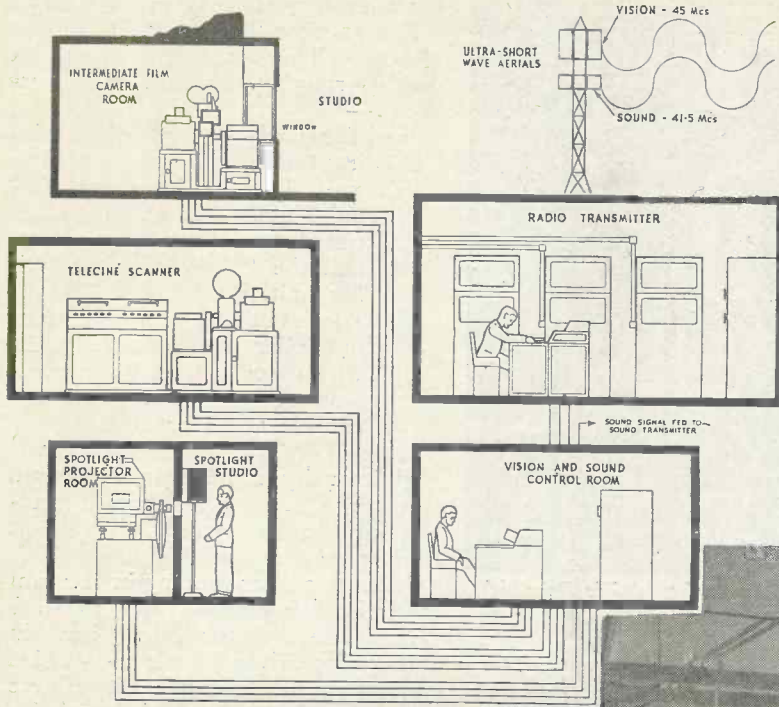

Schematic diagram of the Baird television equipment at the Alexandra Palace.

The tower staircase leads up to the studio floor, passing *en route* a first floor on which are the offices of the engineers. Offices on the second or studio floor are occupied by the productions manager, stage managers and secretarial staff.

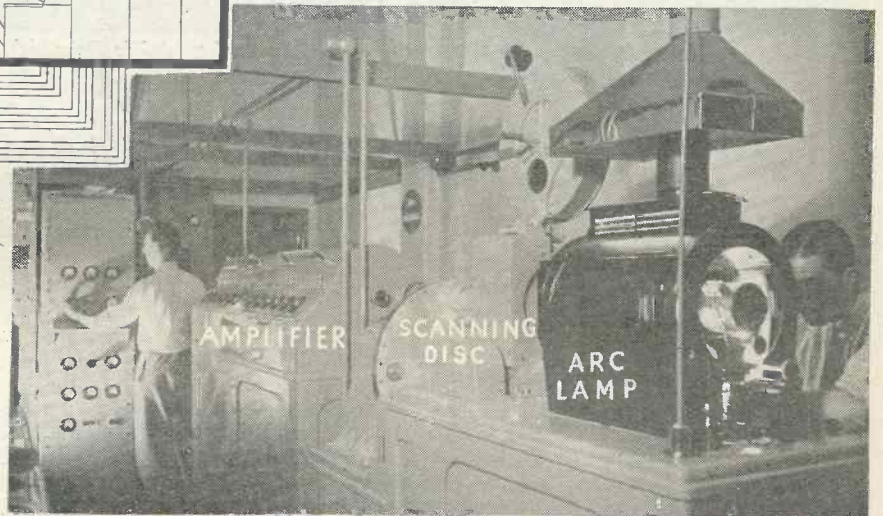

Baird telecine scanners. Monitoring and control racks in background.

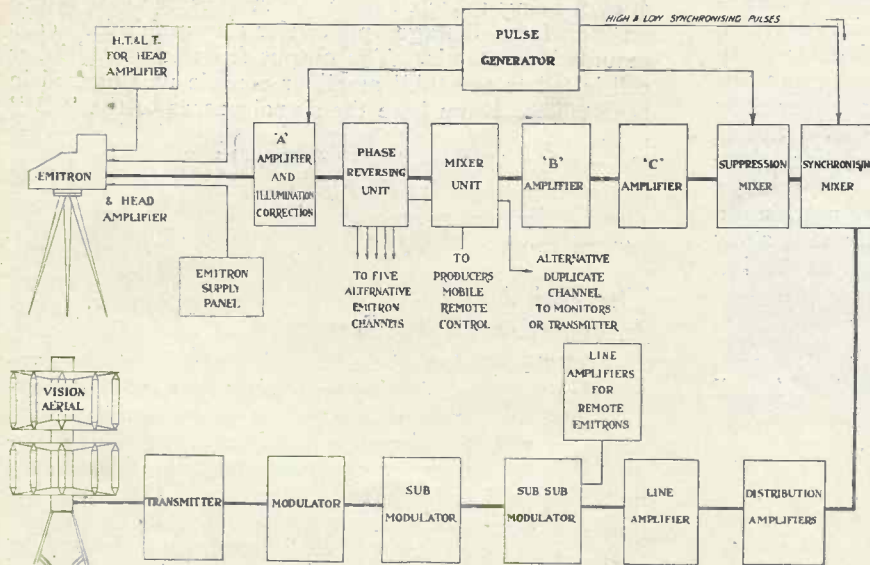

Schematic diagram showing the various stages of the Marconi-E.M.I. equipment.

Several microphone points are installed in each studio, and they are arranged to allow the use of any type of microphone which may be required. Portable stands of the "lazy-arm" type are also provided.

Stages and Lighting

Each studio is fitted with two stages equipped with curtains, the detailed arrangements of the stages and curtains being different in the two studios on account of the different requirements of the two systems. A number of overhead battens, each of which carries several lighting circuits, has been provided in each studio. There is also a large number of wall sockets for portable lighting.

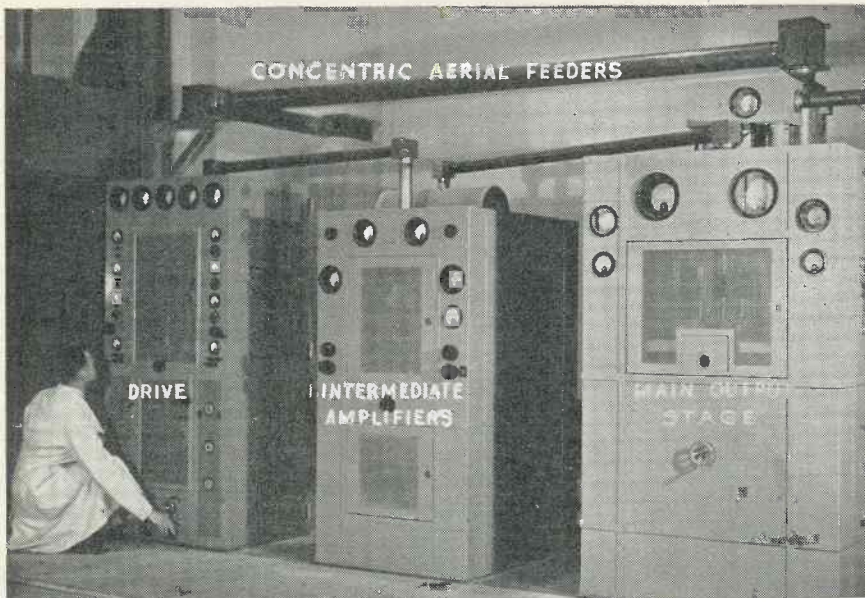

The high-frequency stages of the Marconi-E.M.I. Vision Transmitter showing: (1) The Drive (left), (2) Intermediate Amplifiers (centre), (3) Main output-stage (right).

In each studio a large lighting switchboard has been installed, with provision for the separate control—dimming, etc.—of every circuit. In addition, there are arrangements for pre-selective switching and bank-dimming of any number of circuits, and the whole equipment has been designed to give the maximum possible flexibility. A lighting bridge has been erected across the Marconi—E.M.I. studio to give further lighting facilities.

All the lighting in both studios is at present of the incandescent lamp type, using spot and flood lighting, but modifications are contemplated with developments in television technique.

Ventilation and Heating

Ventilation has been provided in the studios by means of extract fans, the intake for fresh air being provided by openings in the upper part of the windows fitted with filters that clean the air and deaden extraneous noise; the lower parts of the windows are covered by sound-proof shutters during performances. Sound deadening ducts are connected with the outlets. The ventilation is sufficient to keep the studios at a moderate temperature when full lighting, reaching a maximum of approximately 50 kW, is used, and to allow the temperature to be adjusted within normal limits.

The Baird Picture Signals

The Baird Company considered it advisable to install three different types of scanner, namely:—

- (a) Spotlight;
- (b) Intermediate Film;
- (c) Telecine.

The number of lines used to form the image for the Baird system is 240; this was chosen by the Baird engineers after experiments and public demonstrations up to 700 lines in the picture.

The spotlight scanner is employed for televising subjects in the studio, either as close-ups or semi-extended views. This equipment may be divided roughly into two main sections:—

- (a) The projection room containing the light source, scanning unit, line synchronising impulse generator and its associated amplifier equipment, and the "B" console amplifier unit.
- (b) The studio, containing four multiplier photo-electric cells with associated amplifiers and monitor rack, and the "A" console amplifier unit.

A beam of light from an automatic high-intensity arc lamp is focused through a small water-cooled rectangular shaped window situated at the top of the scanning unit. This unit has two discs running in vacuum, each disc being driven by a separate synchronous motor also run in vacuum. The scanning disc driven by a water-cooled motor revolves at 6,000 r.p.m., and has 240 minute apertures arranged in four spiral traces, of sixty holes in each trace, near the outer rim.

The second disc has a slit arranged in a spiral trace near the outer edge, and acts as a rotating shutter so that only one scanning disc hole is exposed to the light beam from the arc lamp at any single instant.

Associated with the scanning unit is a line synchronising impulse generator. This consists of a light source, optical system and photo-electric cell and 240 synchronising slits arranged in a circular trace on the scanning disc itself. This, in conjunction with a special amplifier system, produces square topped synchronising impulses at the end of every scanning line.

The spotlight beam from the scanning unit is focused through the window of the projection room into the studio, being reflected from the subject being televised on to four 5-stage photo-electric multiplier cells mounted on stands. The output from each multiplier cell is fed to the "A" amplifier console unit housed in the studio. From here the signal passes to the "B" amplifier console unit located in the projection room. From the "B" amplifier the signal is fed to an output control amplifier, from which the signal together with the line frequency synchronising signal, passes to the control room.

The Baird Intermediate Film Scanner

A full description of the Baird intermediate film scanner was published in the September issue of this journal and it will suffice therefore to give a brief outline of the more salient features of this system. The intermediate film equipment is used for televising scenes in the large Baird studio. It may be divided roughly into two main sections as under:

- (a) Film processing unit comprising recording cameras, sound head, processing tanks, arc lamp, scanning unit and associated equipment.
- (b) Amplifier desk console unit, containing the "A"

HOW THE INTERMEDIATE SYSTEM OPERATES

and "B" amplifiers, control amplifier, complete with all power supplies, decoupling units, and monitor rack.

The film processing section consists of a tank divided into six compartments, each compartment being used for one stage in processing the film as follows: (1) developing, (2) washing, (3) fixing, (4) washing, (5) scanning, (6) outer jacket containing warm water to maintain the developer and fixing compartments at the correct temperature.

The subject to be televised is photographed on 17.5 m.m. film (half standard 35 m.m. film), with a motion picture camera of the intermittent type, mounted directly above the developing compartment. The film passes through the camera at a rate of 47 ft. per minute, the whole unit being driven by a synchronous motor running at 1,500 r.p.m.

The film, coated with a rapid and sensitive emulsion, after passing through the picture camera, is fed to a sound recording camera situated immediately below, where the sound track is recorded between the perforations and the edge of the film. After leaving the recording camera the film passes into the developer, is then washed, after which it is fixed. It is then finally washed and passes into the water-filled scanning compartment, where it runs over a guide, the complete operation taking thirty seconds.

A beam of light from an automatic arc lamp is focused through the window in the scanning compartment on to the slit in the guide. The image of the moving film passing over the guide is projected by the lamp on to the scanning unit through a combination of lenses.

The scanning unit consists of an encased scanning disc having a circular trace of sixty minute apertures near the outer rim. This disc revolves at 6,000 r.p.m., i.e., four times every picture frame, so as to provide a 240-line picture dissection.

The disc is driven by a water-cooled synchronous motor, both the motor and the disc being run in vacuum. The light variations passing through the apertures of the scanning disc are focused by a lens on to a ten-stage multiplier photo-electric cell contained in a head amplifier, housed on top of the scanning unit.

Associated with the scanning unit is a line synchronising impulse generator, somewhat similar to that used in the spotlight scanner, which produces square-topped synchronising impulses at the end of every scanning line.

The film, having been scanned, passes to a sound head which is mounted directly above the scanning compartment. There, the film runs over a guide located in a small container supplied with a constant flow of water from the water main. A beam of light is concentrated on the sound track of the film as it passes over the guide, the variations of light being focused on to a photo-electric cell.

The output from the head amplifier is fed to the "A" amplifier, which together with the "B" amplifier and control amplifier, is housed in the amplifier desk console unit. Each stage of amplification is provided with a separate H.T. unit and decoupling unit to prevent instability due to back coupling.

The signal from the "A" amplifier is fed to the "B" amplifier, and thence to the output amplifier, control again being provided between these amplifiers. The vision and sound aerial arrays at Alexandra Palace.

The output from the control amplifier, together with the output from the high-frequency synchronising amplifier, is then fed to the control room. A standard monitor rack is included in the equipment to permit the outgoing picture to be viewed.

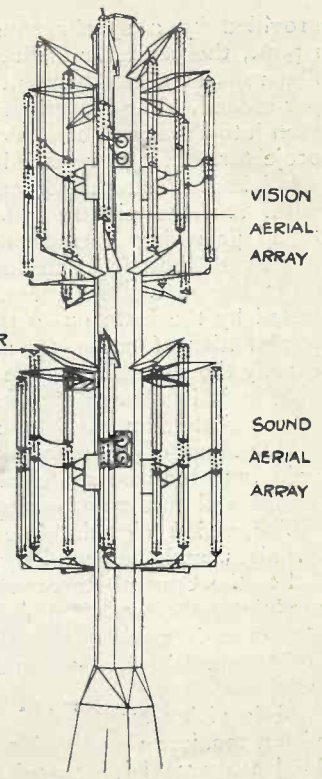

Telecine Scanner

The Telecine scanner is capable of providing television pictures from any standard 35 m.m. sound film. It consists of two main units:

- (a) The projector unit consisting of light source, film drive mechanism and associated optical system, line synchronising impulse generator

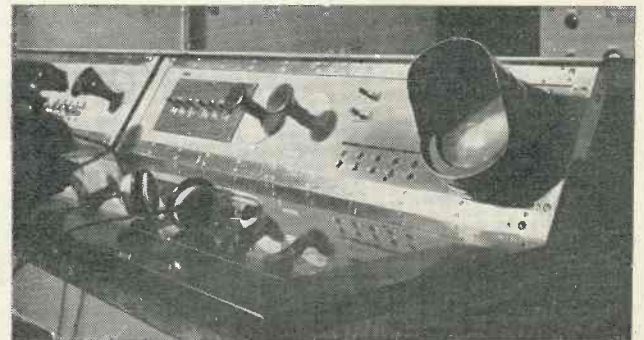

Baird control desk for vision and sound.

Details of our Guaranteed Television Receiver are given on page 548

and its associated amplifier and auxiliary equipment.

- (b) The amplifier unit consisting of the "A" section and "B" section amplifiers complete with all necessary power supplies, decoupling units, together with control and monitor racks.

The film is fed through a projector, the drive being

provided by a synchronous motor running at 1,500 r.p.m., the projector having been modified so that the film runs at a steady uninterrupted rate of 25 frames per second. The film passes through the picture gate, then into the sound head located immediately below the projector, being reloaded finally in the bottom spool box. The shutter on the machine is dispensed with, and the picture gate is water-cooled, a small pump providing a continuous flow for this purpose. A beam of light from an automatic arc lamp is focused on to the gate. The image of the moving film is projected by the lamp on to the scanning unit through a combination of lenses, the actual scanned images being exactly the same size as the original frame. The scanning unit is almost identical in all respects with the intermediate film machine already described.

One stage of the amplifier is arranged to have unity gain, and may be switched in or out in order that a negative picture may be scanned should this be desired.

The vision signals, line and frame synchronising impulses, and the sound signals from each scanner are fed to the Control Room where, any one signal source modulates the two ultra-short wave radio transmitters. Provision is made to handle five programme sources.

The control room equipment consists of the following units:—

Main vision control desk; main sound control desk; vision monitor rack; vision radio receiver rack; check loudspeaker; vision signal termination amplifier rack; line synchronising impulse termination amplifier rack; frame synchronising impulse termination amplifier rack; sound distribution rack; sound rack containing the B.1. and B.2. amplifiers; and two H.T. power unit racks.

The vision signals, line and frame synchronising impulses from the various programme sources are fed to three termination racks with five termination amplifiers in each rack. Each amplifier is provided with a gain control enabling any adjustment in level to be made when required.

The Marconi-E.M.I. System

For the operation of the Marconi-E.M.I. system at the Alexandra Palace six Emitron television cameras and six complete Emitron supply and amplification units are provided, arranged to feed two alternative channels to the vision transmitter. The signals from the Emitrons are amplified two million times, that is from two thousandths of a volt to 2,000 volts before being supplied to the radio transmitter. A special unit supplies all the necessary pulses for synchronisation.

The signals from the Emitron are first amplified in a unit built in the camera itself and the amplified signals then pass via a special cable to the amplifiers in the control room. The arrangement of the equipment allows a selection from any two of the six Emitrons to be made at the same time so that the producer can use one for transmission and then fade over to the other.

The Emitron Camera

The special mosaic plate of the Emitron camera receives the image via a lens and creates small potential differences between the mosaic particles on the front of a mica plate and a metal plate on the back. These

signals are of the order of 2 millivolts. The signals are produced in sequence by the scanning action of a cathode-ray beam and are fed to the input of the first amplifier valve via an electrical contact to the back metal plate.

The camera is sufficiently sensitive to enable it to be used under conditions of normal daylight or studio lighting.

In order to obtain sufficient detail the focus of the cathode-ray beam has been reduced to a spot size of less than one millimeter in diameter. This fine focus is necessary to produce the necessary delicacy of detail. The order of mosaic element size to spot size is such that the camera is capable of greater detail than the 405-line definition of the Marconi-E.M.I. transmission system.

The Head Amplifier

The picture signals from the camera plates are fed straight into the head amplifier housed in the camera itself. This amplifier amplifies the minute signals from the photo-sensitive plate of the camera sufficiently for them to pass down as much as 1,000 ft. of cable until they reach the main valve amplifying equipment.

The head amplifier has four stages comprising an input valve, two resistance capacity coupled amplifier valves, and a pentode output valve. The output stage is designed to match up with the characteristic impedance of the cable, which connects the camera to the later stages of amplification.

The movement of the scanning ray is controlled electro-magnetically both for line and frame scanning frequencies, the main cable entering the bottom of the head and carries within it 18 conductors. This cable not only carries to the main equipment the picture signals from the camera, but supplies to the camera the filament, high-tension and scanning pulses, which are generated for it on the main equipment.

After passing through the multi-core connecting cable from the head amplifier in the camera, the picture signals enter the picture illumination corrector unit, one of which is provided for each of the six cameras. Emitron picture signal trains constituting for example, one line scan, tend to fall in mean level with regard to true black. In order to correct this condition which produces a light or shadow effect over part of the picture, compensating impulses are added to the picture signals in this unit in order to maintain a true "black level" throughout the scan. The picture signals are still A.C. on leaving this unit.

After correction for evenness of illumination the signals enter the phase reverse unit, the purpose of which is for compensating for the use of negative or positive film. This unit consists of a single valve, the output from which can either be taken from the cathode or anode circuit, thus providing alternative phase reversal. There is one phase reversing valve for each of the six camera channels. No magnification is employed in this unit.

The Mixer Unit

The equipment so far described is common to all the cameras, but at this point the signals from any of the six cameras can be caused to pass into the mixer unit.

(Continued on page 599).

Aerial Current Measurement

3.5 watts, so giving ample reserve when modulating the transmitter.

It has been so arranged that a terminal strip to take the filament and H.T. supplies is mounted on the back of each chassis, so that the modulator and transmitter can be coupled together by four wires, giving a very neat appearance.

proved more satisfactory. This tube was mounted inside a bamboo cane and fixed to the side of the chimney. An odd length feeder was then connected, and, although reports indicated a decrease in signal strength in certain areas, the overall field strength was considerably improved.

Readers who care to erect the copper

Components for TWO-STAGE AMPLIFIER

CHASSIS.

1—Aluminium 14 by 8 by 2 ins., 16 gauge (Peto-Scott.)

CONDENSERS, FIXED.

- 2—.01 mfd. type M. (T.C.C.)
- 1—.001 mfd. type M. (T.C.C.)
- 1—.1 mfd. type tubular. (T.C.C.)
- 1—.2 mfd. type 250 volt working. (T.C.C.)
- 1—.25 mfd. type 3013. (Dubilier.)
- 1—.50 mfd. type 0281. (Dubilier.)
- 2—.16 mfd. 500 volt working. (Ferranti.)

CHOKE, HIGH FREQUENCY.

1—Type HF10S. (Bulgin.)

CHOKE, LOW FREQUENCY.

1—60 m/a 30 Henry. (Bryan Savage.)

HOLDERS, VALVE.

2—4-pin chassis mounting type V1 without terminals. (Clix.)

1—7-pin type V2 without terminals. (Clix.)

PLUGS, TERMINALS.

1—Terminal strip type 996. (Eddystone.)

RESISTANCES, FIXED.

- 1—50 ohm 3 watt Ohmite. (Graham Farish.)
- 1—140 ohm 3 watt Ohmite. (Graham Farish.)
- 1—500 ohm type 1 watt. (Erie.)
- 1—10,000 ohm type 1 watt. (Erie.)
- 1—25,000 ohm type 1 watt. (Erie.)
- 1—50,000 ohm type 1 watt. (Erie.)
- 2—500,000 ohm type 1 watt. (Erie.)

RESISTANCES, VARIABLE.

1—50,000 ohm potentiometer. (Reliance.)

SUNDRIES.

24—6BA brass roundhead bolts with nuts and washers. (Peto-Scott.)

3—Yards connecting wire and sleeving.

SWITCHES.

2—Type S80T. (Bulgin.)

TRANSFORMER, MODULATION.

1—Type OPM1. (Ferranti.)

TRANSFORMER, MAINS.

1—Type X256. (Sound Sales.)

No difficulty should be experienced in obtaining ample modulation, and when checked with one of the new Ferranti low-resistance hot-wire meters, a very healthy increase in aerial current is obtained.

Owing to valve variation it was discovered that with certain specimens 100 per cent. modulation was not possible with the circuit as shown. The only alteration, however, necessary was to vary the value of the grid resistance in the P.A. circuit.

Constructors who use 6 volt, .3 amp. bulbs to indicate aerial current will find that these burn out very quickly with full modulation, indicating ample radiation for the low wattage used.

All the original tests were carried out with a simple half-wave Hertz aerial,

tube on large stand-off insulators in an efficient manner will find this to be the best type of radiator. The same aerial is, of course, used for reception as for transmission.

For the purpose of experiment a circuit (now undergoing tests) of an oscillator amplifier using Cosmor 240B valves is shown. It is fundamentally the same as for the 53's, but readers should experiment with the valves for R1 and R2. It will be considerably quicker to use a bias battery to obtain the correct value and to measure grid current and calculate the correct values for R1 and R2. Although the input for the modulator is not shown, this should be connected in series with the high-frequency choke to the P.A. in the same way as for the 53's.

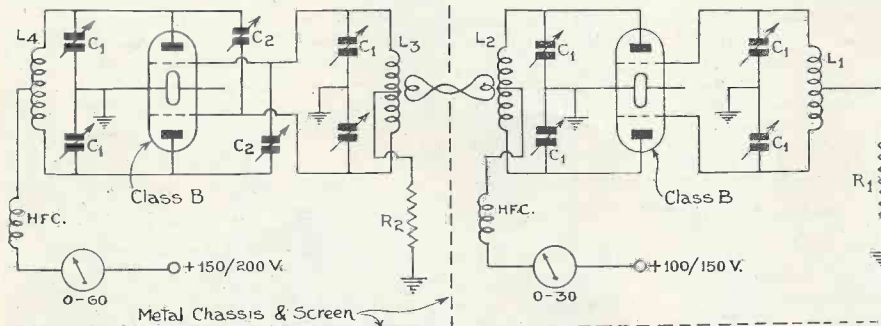

With battery valves this circuit should be used as the basis of the transmitter.

and, although good radiation was obtained, this was highly directional and not entirely suitable for amateur use.

Subsequent tests with a half-wave vertical aerial consisting of 7 ft. 10 in. of 1/4 in. 16-gauge copper tube have

The approximate anode current of the oscillator is 12 m/a and approximately 20 m/a for the P.A. These figures are obtained with an anode voltage of 150, so will serve as a guide to constructors in obtaining the correct bias value.

The Mervyn-Mallory Grid Bias Cell

THE Mervyn Sound and Vision Co. have introduced the latest Mallory bias cell for use in receivers requiring a potential of 1 volt. This cell measures 1 1/32 ins. by 3/8 in. the case forming a negative pole, the positive connection being made to a carbonised plate in the centre. A no-current potential of 1 volt is given, which is constant within wide limits of temperature and super-imposed alternating current.

The principal use of this cell is to provide the low negative potential in A.V.C. and H.F. bias circuits. It takes the place of the conventional bias resistance and high capacity shunt condenser in the cathode circuit of L.F. valves.

A second system of connection is to use it in the grid circuit of the amplifier with either directly- or indirectly-heated valves. In this way quality is improved as the valves are less susceptible to overload than when using automatic cathode bias.

Battery-operated receivers can make full use of this cell to provide bias with a high-frequency amplifier, instead of using a screen-grid valve with a fixed grid bias; a valve with variable mu characteristics biased to 1 volt will give better quality and freedom from cross modulation.

The cell has an indefinite life so that it is very suitable for radio use for it can be fitted in place of the low potential battery and forgotten.

Supplies can be obtained from the Mervyn Sound and Vision Co., of 4 Holborn Place, W.C.1.

Television Studios for Birmingham

The B.B.C. are searching for a site for a new building that will house 13 or 14 studios. If the transmissions from the Alexandra Palace are satisfactory, the Midland Regional station should be the first to have television outside of London. Providing the new Birmingham "B.H." is large enough to provide all of the studios asked for, there should be plenty of room for television.

Television in Scotland

Television with synchronised sound was demonstrated for the first time in Scotland at the Scottish Radio Exhibition, held in St. Andrew's Hall, Glasgow. The apparatus consisted of a transmitter and six cathode-ray receivers which were demonstrated by Mr. J. H. Reyner, B.Sc. Pictures were entirely satisfactory and were no less than 10 ins. by 8 ins., the same size as shown at Radiolympia.

IT PAYS TO USE EDDYSTONE

Get your copy of the
**1937 EDDYSTONE
SHORT WAVE MANUAL**
*From your RADIO DEALER,
W.H.SMITH, or in difficulty
POST FREE 1/-*

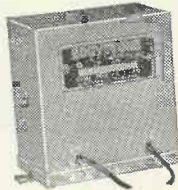

AIR TUNED I.F. TRANSFORMER

Compact unit with high efficiency air trimmer and genuine litz wound coils. Total tuning coverage 400 to 500 Kc/s. Gives high stage gain with approximately 9 Kc/s bandwidth. No. 1,014. 450 Kc/s. Price 13/6.



ULTRA SHORT-WAVE H.F. CHOKES

These chokes are single layer, space wound on DL-9 formers, and have an exceedingly low self-capacity. 24-10 metres. No. 1011. D.C. Resistance 1.3 ohms. Price 1/3. No. 1021. D.C. Resistance 0.4 ohms. Price 1/3.

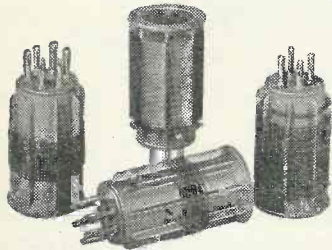

INTERCHANGEABLE COILS

New low loss formers of DL-9 high-frequency insulation. Rigidly made and each coil matched. First-class results assured. 4-pin coils have two windings, 6-pin three windings. No. 959 6-pin Set of 4 12-170 metres Price 16/- No. 932 4-pin " " " " " " Price 14/-



MIDGET INSULATOR
Made from Frequentite for high frequency work, with N.P. metal parts. 1" overall height. No. 1019. Price 4½d. each.



UNIVERSAL S.W. VALVEHOLDER

A low loss holder for above or below baseboard use. The valve enters the contacts from either side. There is no measurable increase of self-capacity to that already in the valve base. DL-9. H.F. dielectric, one-piece noiseless contacts.

No. 1015. 4-pin, 1/3. No. 1016. 5-pin, 1/5. No. 1024. 7-pin, 1/8.

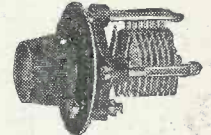

MIDGET CONDENSER

A small-size variable condenser for S.W. circuits. Soldered moving and rotor vanes, with DL-9 H.F. insulation. With knob and scale. 3-65 m.mfd. No. 1013, Price 4/3.



FLEXIBLE COUPLER
Free from back-lash but very flexible, this coupler banishes alignment troubles. DL-9. H.F. insulation. For ½" spindles. No. 1009. Price 1/6

IMPROVED MICRODENSER No. 900

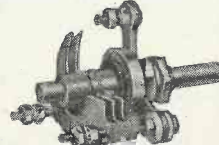

For ultra H.F. and general S.W. use CALIT insulation, low series resistance, noiseless movement, extended ½" spindle for ganging. 20 m.mfd., 3/9d.; 40 m.mfd., 4/3d.; 100 m.mfd., 5/-.

IMPROVED SCIENTIFIC CONDENSER No. 942

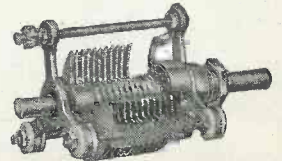

A Condenser representing advanced technical H.F. design. CALIT insulation, all brass construction, soldered vanes, noiseless movement, extended ½" spindle for ganging. 180 m.mfd., 7/6d.

EDDYSTONE SHORT WAVE COMPONENTS

STRATTON & CO., LTD. Bromsgrove Street, BIRMINGHAM. LONDON Service Depot: Webb's Radio Stores, 14 Soho Street, Oxford Street, W.

'TELEVISIONS GUARANTEED'

CATHODE RAY RECEIVER

MERVYN SPECIFIED

The secret of the vision receiver is in the I.F. Transformers. Those used in Television's guaranteed receiver are a special MERVYN design and manufacture and only have to be plugged in. Four type T.I.F.I. transformers and one detector unit are required. See list below for specified parts.

| | | | | | |
|--|------|------|---------------------------------------|------|-----|
| T.I.F.I. Vision Transformers | each | 9/6 | T.U.S.I. Special H.F. choke | each | 1/6 |
| Special diode unit complete with valve | each | 25/- | Condenser bracket solid | each | 1/6 |
| Cable cord special rating 7 leads | each | 3/6 | With Eddystone variable condenser | each | 5/9 |
| Power pack baseboard drilled | each | 1d. | Power pack bracket less 10 pt. socket | each | 1/3 |
| Insulated plate, less terminals | each | 9d. | Bracket for U.12 valve and condensers | each | 9d. |

Write for full details of the complete list of units for this wonderful receiver including the time base, power packs, cathode ray tubes, relays, etc. EVERY INDIVIDUAL COMPONENT OR COMPLETE KITS FOR THIS GUARANTEED RECEIVER CAN BE SUPPLIED. MERVYN who are well known in many parts of the world for special aids to simplify Television have produced reasonably priced units for the amateur among which are available:—

- A pretuned converter for reception of the Alexandra Palace sound programmes—no tuning. Price with valve ... 60/-
- A cathode ray exciter unit and control panel kit... £5/17/6
- Cathode ray tube heater transformer with 4-volt primary ... 7/6
- A vision receiver, proven on the Alexandra Palace television. Provision for synchronising output. Special dipole aerials not required. Price including 8 valves ... £16/10/-
- 4,000 volt working condensers .25 MFD. ... 9/-

MERVYN pioneers of 30 line television now pioneer HIGH DEFINITION pictures in the HOME.

THE MERVYN SOUND and VISION CO., LTD.
4, HOLBORN PLACE, LONDON, W.C.1 Telephone: HOLborn 7709
Managing Director: W. J. NOBBS, F.T.S., A.M.I.R.E.

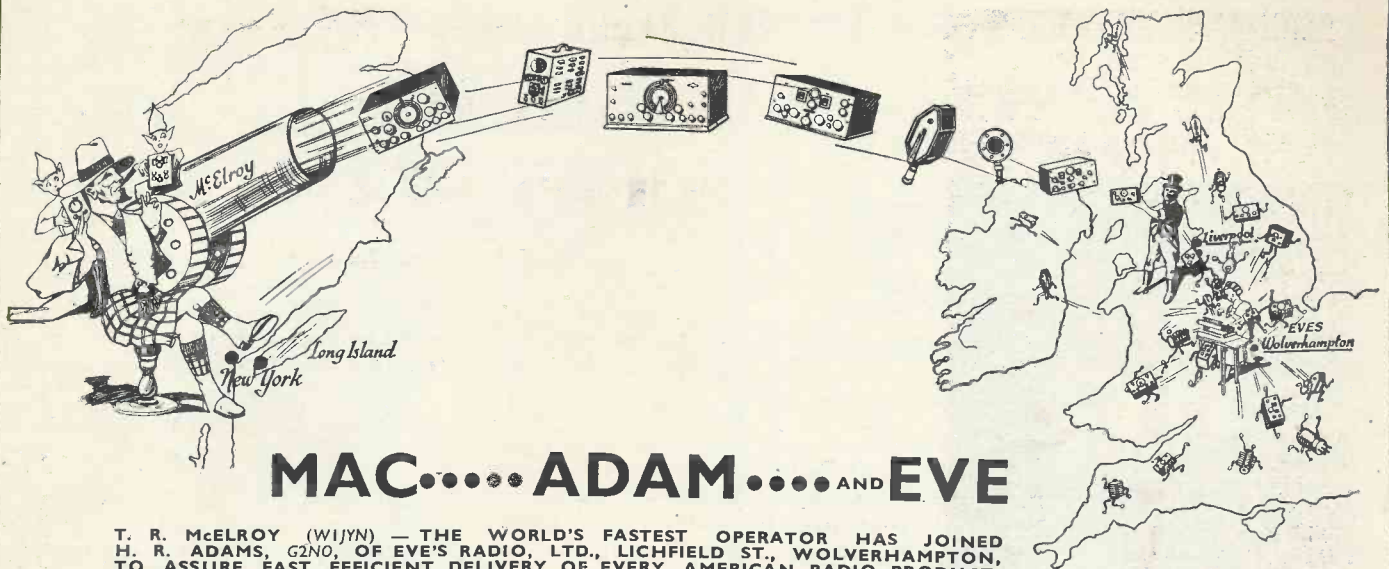

MAC...ADAM...AND EVE

T. R. McELROY (W1JYN) — THE WORLD'S FASTEST OPERATOR HAS JOINED
H. R. ADAMS, G2NO, OF EVE'S RADIO, LTD., LICHFIELD ST., WOLVERHAMPTON,
TO ASSURE FAST EFFICIENT DELIVERY OF EVERY AMERICAN RADIO PRODUCT.

CONSULT EVES.....THEY WILL TEMPT YOU

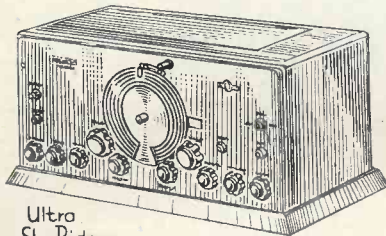

Ultra Sky Rider

THE ULTRA SKY RIDER

- Built-in Noise Silencer.
- 1,600 K.C. Iron-Core Air-Trimmed I.F. Transformers.
- Electro-Mechanical Band Spread.
- 338 Degree Dial.
- Direct Calibration Tuning—No Charts or Tables.
- Individual Coils for each band.
- Generous Isolantite Insulation.
- 100 K. C. Expansion.

AMATEUR NET PRICE, £34 0s. 0d.

THE NEW 1937 SUPER SKY RIDER

- 11 Tubes—10 of them metal.
- 40 M.C. to 535 K.C. in 5 Bands.
- 338 degree main tuning dial.
- Electro-Mechanical Band Spread.
- 14 Watts Undistorted Out put.
- Direct Calibration Tuning—No Charts or Tables.

AMATEUR NET PRICE, £31 0s. 0d. CRYSTAL GATE MODEL.

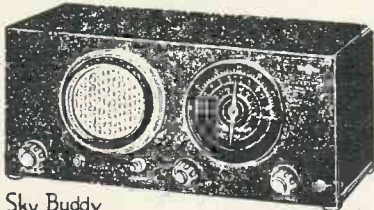

Sky Buddy

THE SKY BUDDY

- 18 to 555 meters (16.5 Mc.-544 Kc.) Three Bands.
- Combined I.F. and Beat Frequency Oscillator.
- 5 tubes do the work of 8.
- Automatic Volume Control—with on-off switch.
- Greater Band spread—36 to 1.
- Bands changed with switch.
- Improved tuning control—no backlash.
- Direct reading calibrated dial.
- Single tuning control.
- Built-in power supply.
- Built-in speaker.

AMATEUR NET PRICE, £9 0s. 0d.

STANDARD FEATURES ON EVERY RME-69.

- Planetary Vernier Dial Drive.
- Full Electrical Band-Spread.
- Individual Dial Operation.
- Six Band Tuning Range.
- Calibrated Microvolt-R. Meter.
- Built-in Monitor Circuit.
- Fixed Coupling I.F. Transformers.
- Six Volt Tubes.
- Crystal Filter Circuit.

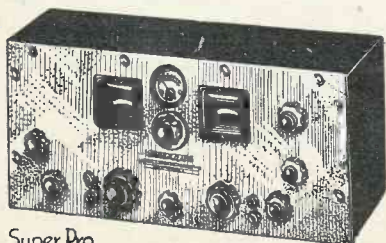

Super Pro

RME69

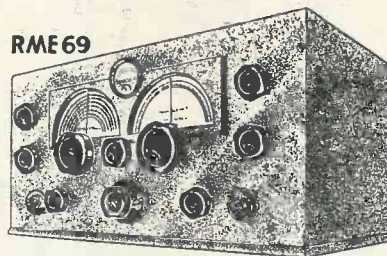

AMATEUR NET PRICE, £38. SPEAKER, £2 10s. 0d.

THE WORLD'S MASTERPIECE

Hammarlunds Super Pro. Surpasses any other receiver. 6 models. SPIOX—Super-pro. with xtal Gate and 10" Speaker.
AMATEUR NET PRICE, £65 0s. 0d.



THE HARVEY—BURNHAM

40-watt crystal-controlled phone and c.w. transmitter. Complete instrument including two built-in power packs, speech amplifier, and class B modulator, with all tubes, crystal microphone, and one set of coils.

AMATEUR PRICE, £63 0s. 0d.

McELROY'S FAMOUS BUG KEY

Obtainable only from Eve's, 35/-.

| | | | | |
|------------------------|-----|-----|-----|------|
| Shure Xtal Mike Head | ... | ... | ... | 85/- |
| Astatic Xtal Mike Head | ... | ... | ... | 65/- |
| Taylor T55 Tube | ... | ... | ... | 45/- |
| Amperex HF 100 | ... | ... | ... | 65/- |

ANY INSTRUMENT MAY BE PURCHASED UNDER OUR "PAINLESS EXTRACTION SYSTEM."

EVE'S RADIO LIMITED

11, Lichfield Street, Wolverhampton.
Telephone: W'ton 22886.

"The Units in a Cathode-ray Receiver."

(Continued from page 554.)

oscillator from the varying load imposed by different lengths of aerial. Again, a power pack is required to energise the receiver which is connected by a multi-way cable in the same way as the sound receiver is connected.

As regards the power packs, however, it is quite feasible to make one unit do for both receivers. It simply means employing a transformer and valve that will give twice the current output but with the same voltage. So it will be realised that whether one uses a single or double power pack it is purely a matter of taste.

Both these receivers are loosely coupled to a common aerial and as only one station is to be received on each set, the controls can be left set. In fact, many constructors will use pre-set tuning condensers, so obviating the necessity of mounting the receivers with controls jutting through the panel.

Then comes the most important item in the vision section—the cathode-ray tube. This tube is mounted either horizontally so that the picture is viewed directly from the face of the tube, or vertically with the picture reflected into the line of sight by means of a mirror mounted at an angle of 45 degrees to the face of the tube.

Constructors will have most difficulty with the final two units, one being a double time base, and the other a high voltage power pack. Voltages of between 2,000 and 4,000 volts are needed with the average cathode-ray tube. The amount of voltage applied is dependent on the size of the tube. Some of the larger tubes used in laboratories use up to 8,000 volts, while small 5 in. models work satisfactorily with 2,000 volts. This power pack can be mounted right out of the way of the rest of the equipment, as the only control is the master switch which can be remotely connected to the operating panel.

The double time base generally uses about six valves, and its function is to enable the viewer to control the construction of the picture, also the synchronising with the transmission and the intensity of the light.

By means of the time base the picture is brought into the centre of the screen and squared up. Roughly speaking the time base is equivalent to the tuning system in a sound receiver.

GALPINS

ELECTRICAL STORES
75 LEE HIGH ROAD,

LEWISHAM, LONDON, S.E.13

Tel.: LEE GREEN 5240. Cash with Order or C.O.D.

UNIVERSAL MOTORS, A.C. or D.C., approx. $\frac{1}{4}$ h.p., 200/250 v., for television, sewing machines, grinding, drilling, etc., 19/6. Post 1/-.

UNIVERSAL MOTORS, A.C. or D.C., approx. $\frac{1}{8}$ h.p., 200/250 v., for baby cines, television, or any small power work, 12/6. Post 6d.

"FOSTER" AUTO. TRANSFORMERS as new, 200 v. to 100 v. or vice versa, 750 watt, 25/-; 1,650 watt, 35/-; 2,500 watt, 42/6. Carriage forward.

LARGE TRANSFORMERS, windings not known, 1 kw., 15/-; 2 kw., 25/-; 3 kw., 32/6. C/F.

ROTARY CONVERTORS, 200 v. D.C. input, 100 v. A.C. 100 watt output 60/-; 200v. D.C. input, 100v. 200 watt A.C. output, 95/-; 200 v. input, 220 v. 660 watt A.C. output with starters, £8/10/0. C/F. Guaranteed.

VARIABLE RESISTANCES, 300 ohms \pm amp., 20 studs, small size, 12/6.

FIELD COILS, 2 lb. of 20-G. D.C.C. wire, 1/6. Post 3d.

HIGH GRADE SWITCHBOARD, volt and ammeters, 12/6 each. Post 1/-.

RIGHT ANGLE DRIVES TRANSMIT., 1 h.p. heavy gunmetal gears, 10/-.

DYNAMOS for Lighting or Charging, all shunt wound, fully guaranteed. 100 volt 10 amp., 60/-; 50/75 v. 12 a., 65/-; 40 v. 15 a., 70/-; 150 v. 1 a., 17/6; 100 v. 3 a., compound, 30/-; 200 v. 3 a., compound, 50/-; 20 v. 5 a., compound, 30/-; Aero dynamos, 12 v. 8 a., 10/-, all C/F.

WILSON WOLF DYNAMOS, 50/75 v. 10 a., 50/-.

MOTOR BLOWERS, 4 in. or 2 in. outlet, 100 v. D.C., 35/-.

CHARGING RESISTANCES or Shunt Regulators. Stud, switcharm type, 12/6 each, to suit your requirements.

C.A.V. AUTOMATIC CHARGING CUT-OUTS, suit any voltage, 7/6 each.

ISENTHAL VARIABLE RESISTANCE, to carry 10 to 15 amps., fitted 0 to 15 a/meter and Pilot Lamp, as new, 17/-.

EX-R.A.F. MORSE KEYS, fully adjustable, 2/6 each. Post 6d.

MULTIPLE SWITCH with sensitive actuating Relay, as new, ex. automatic Phones, 4/6 each.

TRANSMITTING VARIABLE CONDENSERS, 0.0005 mf., in glass case, 12/6 each.

ELECTRIC LIGHT CHECK METERS, kilowatt hour type, 200/250 v. single phase, for subletting, etc., 6/- each. Post 1/-.

WESTERN ELECTRIC MICROPHONES, solid back type, very sensitive, 2/6 each. Microphone Transformers, 2/6 each.

MICROPHONE BUTTONS, highly sensitive, 6d. each. Post 3d.

RESISTANCE MATS, wound with Eureka wire, gauge 26, size 24 in. square, 600 ohms, $\frac{1}{2}$ amp., 5/- each.

G.P.O. GLASS TOP RELAYS, Type B, highly sensitive, 7/6 each.

DUPLEX TELEGRAPH MORSE KEYS, send-and-receive type, 12/6.

G.P.O. HIGHLY SENSITIVE GALVANOMETERS, vertical type, 5/- each.

ELECTRIC COUNTERS, to 9,999 from 3 to 12 v. working, small current, 2/6.

LABORATORY CONDENSERS, 3 $\frac{1}{2}$ mf., fitted 10 knife switches. High voltage, 15/- each. C/F.

QUARTZ TUBES, 10 in. by $\frac{3}{8}$ in., 5/- per doz.

BELLING ELECTRIC FIRES, good condition, 1 kW, 12/6; 2 kW., 17/6. Fully guaranteed. C/F.

MOTOR GENERATORS, 100 to 250 volt, 600 watt, D.C. to D.C., 15/-.

ELECTRIC LIGHT SHILLING SLOT METERS, 200/250 v. 50 cy., single phase, 17/6 each. Post 1/-.

LATE TYPE CHECK METERS, 200/250 v. 5 a. 50 cy., single phase, 10/- each. Post 1/-.

EXIDE 2-volt 30/60 a.h. unspillable Accumulators, type 3PZ3. Guaranteed sound. 2/6 each. Post 1/-.

VALVES, by well-known makers. 2-volt general purpose type, only 1/- each, 3 for 2/6.

SHORT WAVE COILS, 14 to 150 metres, with circuit diagram. Set of 3 coils, 5/-, post free.

T.C.C. ELECTROLYTIC (Wet) 8 mf. Condensers, 450 v. working, 2/9 each.

WESTERN ELECTRIC 10 mf. Condensers, 500 v. working, 2/9 each.

MOVING COIL METER Movements for recalibrating into multirange meters, 5/6 each.

X-RAY TUBES, by well-known makers, 15/- each. C/F. With Platinum Targets, 17/6, 25/-.

MERCURY BREAKS, 25/-, with 100/250 v. motor, 35/- each.

PEDESTAL TELEPHONES, with Automatic Dials, 7/6 each.

AUTOMATIC TELEPHONE DIALS, 0 to 9, 2/- each.

MAINS CHOKES, 20 and 30 henry, 40, 60, 80 mA., 1/3, 1/9, 2/6 each.

BUY your KIT FROM

PETO-SCOTT

The ONLY firm with
17 YEARS' EXPERIENCE
IN SUPPLYING THE SPECIALISED REQUIREMENTS OF THE CONSTRUCTOR

SEND FOR DETAILED PRICED LISTS OF FIRST SPECIFIED PARTS of any "Television" sets. Miscellaneous Components, Kits, Finished Receivers or Accessories for Cash or C.O.D. or on our own system of Easy Payments. C.O.D. orders value over 10/- sent carriage and post charges paid (GREAT BRITAIN ONLY).

TOBE AMATEUR COMMUNICATIONS RECEIVER KIT "A" Cash or C.O.D. **£18 7 6**
Carriage paid

Or £4 deposit and 11 monthly payments of 29/-
Author's kit of first specified parts, including ready-drilled chassis and panel, less valves, cabinet and speaker. Peto-Scott ready-drilled chassis and panel £11s. 9d. 8 Specified Valves ... £412s. 0d. Tobe All-Wave Tuning Unit, £6 10s. 0d., or 10/- down and 11 monthly payments of 12/-.

5-8 metre SOUND RECEIVER KIT "A" Cash or C.O.D. **£4 6 0**
Carriage paid

Or 12 monthly payments of 7/9
Author's kit of first specified parts, including ready-drilled panel and chassis, less valves, cabinet and speaker. Peto-Scott ready-drilled chassis and panel ... 11s. 3d. Peto-Scott Aluminium Cabinet ... £15s. 0d. 4 Specified Valves ... £15s. 3d.

2-STAGE AMPLIFIER KIT "A" Cash or C.O.D. **£6 11 6**
Carriage paid

Or 12 monthly payments of 12/-
Author's kit of first specified parts, including ready-drilled chassis, less valves. Peto-Scott ready-drilled chassis ... 8s. 6d.

PETO-SCOTT Co., Ltd. 77, (T.9.), City Rd. London, E.C.1.
Telephone: Clerkenwell 9406/7.
West End: 62 (T.9.), High Holborn, W.C.1.

MATHEMATICAL PRECISION

For Quality and Precision apparatus this journal specifies "Reliance"

POTENTIOMETERS & VOLUME CONTROLS
In Reliance Volume Controls and Variable Resistances the wire is wound with great precision on a very thin bakelite former. The wire is permanently secured in position by an elastic compound obviating risk of movement.

RELIANCE
Specified for the **RELIANCE**
TOBE RECEIVER and the **TWO STAGE AMPLIFIER** THE PRODUCT OF SPECIALISED RESEARCH

described in this issue
RELIANCE MANUFACTURING CO.,
(Southwark) LTD., Westbury Road, London, E.17



PIEZO QUARTZ CRYSTALS

1.7 mc., 3.5 mc., and 7.0 mc., Amateur Bands.

OUR NEW CATALOGUE Power Type Standard Type 20/- post free 15/- post free

CRYSTAL HOLDERS:—
Type A, Open Electrodes, 4s. 6d. post free.
Type B, Totally enclosed and dustproof, 8s. 6d. post free.

THE QUARTZ CRYSTAL CO., LTD.
63 & 71, Kingston Road, New Malden, Surrey
Telephone: MALDEN 0334.

NEW B.T.C. GUINEA KIT

- U.S.W. TELEVISION KIT, 5-10 METRES
 - Tested 25 miles from ALEXANDRA PALACE
 - Hear Television Sound Programmes on your Speaker.
 - SHORT WAVE GUINEA KIT, 13-52 metres.
 - CONVERTER-ADAPTOR OR 1 VALVER.
- Order your U.S.W. or S.W. Guinea Kit To-day.
State if mains or battery type required.
- MERVYN TELEVISION APPARATUS

Highly successful tests have proved this to be the best available to amateurs.

"See for Yourself" with Mervyn Apparatus.
Send for Descriptive Leaflets "S.W.," "U.S.W.," or "MSV Television" as required, enclosing 1½d. stamp.

BENNETT TELEVISION Co., REDHILL

- LATEST CALL BOOKS (September) ... 6s. 0d.
A.R.R.L. HANDBOOKS ... 5s. 3d.
"RADIO" HANDBOOKS (By Jones) ... 5s. 3d.

HINTS AND KINKS—this book is a compilation of hundreds of good ideas which amateurs have found helpful. It will return its cost many times in money savings—and it will save hours of time ... 2s. 6d.

All these post free.

G5KA, (Dept. T), 41 Kinfauns Road, Goodmayes, ILFORD : : : : : ESSEX.

WE CAN SUPPLY

All first specified parts for the **CLASS A HIGH FIDELITY AMPLIFIER**

£26 Carriage Paid. Cash with order or C.O.D.

UNIVERSAL AMPLIFIERS.

6-8 Watts undistorted output
£6 10 0. Carr. Paid. Cash with order or C.O.D.

A.C. Double Push-Pull R.C.C. Coupled. **AMPLIFIER.**

Undistorted output 5-Watts.
£7 5 0. Carr. Paid. Cash with order or C.O.D.

We can supply **KIT** of parts for the **AMATEUR BAND S.S. SUPER-HET** and **TOBE AMATEUR COMMUNICATION RECEIVER** described in this issue, at very competitive prices.

We can supply an equivalent for any British type of Valve at an appreciably lower price. These valves are Guaranteed for a period of 6 months from date of purchase and the performance to be in no way inferior to that of the original valve.

Send for comprehensive List "T.S."

CHAS. F. WARD,

46, Farringdon Street, London, E.C.4.
Telephone : Holborn 9703.

**"TELEVISION"
COUPON
and SHORT-WAVE WORLD"
FOR FREE INQUIRY SERVICE**

Name _____

Address _____

October, 1936

We Supply all Components for the **GUARANTEED CATHODE RAY RECEIVER. THE SECRET** of First Class Reception of **ALEXANDRA PALACE** Transmissions are the **I.F. TRANSFORMERS** Specially Wound for this work, Price 9/6d., post 4d.

DOUBLE TIME BASE in Kit Form with Circuit diagrams, less Valves, £6 10s.

EXCITER UNIT KIT, £5 17s. 6d. with details of Cathode Ray Modern Practice, price 2/6d., post 4d.

CATHODE RAY TUBES, Gas Filled 10 c/m, New Conditions, three only, price £5 0s. 0d.

TELEVISION RESEARCH SOUND ON FILM CAMERA, Standard Size Film, complete with 3-Phase Motor, 200/220 Volts, 1,000 ft. G.B. Magazine. Optical equipment, and Numerous Accessories. Price, 75 guineas. Particulars on Request.

H. E. SANDERS & CO. 4 Grays Inn Road

Tel. No. : Chancery 8778. London, W.C.1

INDEX TO ADVERTISERS

| | |
|---|-----------------|
| | PAGE |
| Automatic Coil Winder | 593 |
| Baird Television | 563 |
| Belling & Lee, Ltd. | Cover ii |
| Bennett Television Co. | Cover iii |
| Bulgin, A. F., & Co., Ltd. | 545 |
| Chapman & Hall | 597 |
| Edison Swan Electric Co., Ltd. | Cover iv |
| Eves Radio | 591 |
| Ferranti, Ltd. | Cover ii |
| Fluxite, Ltd. | Cover ii |
| Galpin's | 607 |
| General Electric Co., Ltd. | 564 |
| G5KA | Cover iii |
| Henley, W. T. | 597 |
| High Vacuum Valve Co., Ltd. | 599 |
| Jackson Bros. | 604 |
| Lectro Linx, Ltd. | 599 |
| Marconi Telegraph Co. | 545 |
| McGraw-Hill Publishing Co., Ltd. | 593 |
| Mervyn | 589 |
| Peto Scott, Ltd. | 607 |
| Pilot Radio | 601 |
| Premier Supply Stores | 603 |
| Quartz Crystal Co. | 607 |
| Radio Resistor Co., Ltd. | 605 |
| 362 Radio Valve Co. | 606 |
| Radio Society of Great Britain | 608 |
| Raymart Manufacturing Co. | 604 |
| Reliance Manufacturing Co. | 607 |
| Sanders, H. E., & Co. | Cover iii |
| Savage, Bryan | 597 |
| Scophony, Ltd. | 592 |
| Sound Sales, Ltd. | 545 |
| Stratton & Co., Ltd. | 589 |
| Television Society | 608 |
| The British Institute of Engineering Technology | 606 |
| The Technological Institute of Great Britain | 605 |
| Varley | 606 & Cover iii |
| Ward, Chas. F. | Cover iii |
| Waverley Book Co. | 605 |
| Westinghouse Brake & Signal Co., Ltd. | 546 |
| Whiteley Electrical | 595 |

**MISCELLANEOUS
ADVERTISEMENTS**

The charge for advertisements in these columns is 12 words or less 2/-, and 2d. for every additional word. All advertisements must be accompanied by remittance. Cheques and Postal Orders should be made payable to Bernard Jones Publications Ltd., and crossed, and should reach this office not later than the 15th of the month previous to date of issue.

JOHN SALTER of Featherstone Buildings, Holborn, W.C. Pioneer, since 1927, of Television components, will be pleased to hear from old friends and new customers requiring up-to-date apparatus.

WANTED. Mervyn Midget Duosphere Mirror Drum Receiver with amplifier and grid bias eliminator, mains operated. Richardson, 10, Fawdon Lane, Fawdon, Newcastle-on-Tyne 3.

**PATENT AND TRADE
MARK AGENTS**

GEE & CO. (Estab. 1905), patents and trade marks throughout the world (H. T. P. Gee, Mem.R.S.G.B., A.M.I.R.E., etc.), 51-52, Chancery Lane, London, W.C.2 (2 doors from Government Patent Office.) Phone: Holborn 1525. Handbook free.

KINGS PATENT AGENCY LTD. (B. T. King, Patent Agent) 146a, Queen Victoria Street, London, E.C.4. **ADVICE,** Handbook and Consultations free Phone City 6167.

SITUATIONS VACANT

REQUIRED IMMEDIATELY, Television Engineer with sound practical and theoretical knowledge of Television design. Good salary and prospects for right man.—Apply, stating full particulars of experience, etc., to Box No. 7.

"Pilot All-Wave Radio"

(Continued from page 608).

bined on-off switch and tone corrector, master volume control, four-band wave-change switch, and a two-in-one tuner. With the tuning knob in the normal position, a ratio of 12½ to 1 is obtained, but by merely pulling out the same knob the ratio is increased to 95-1.

Our tests shows that this receiver will bring in a very good selection of short-wave and medium-wave stations even under adverse conditions; while the wide short-waveband brings in police, aircraft, shipping, and other transmissions of a similar type. The short-wave section must not be confused with the restricted bands which on some receivers barely covers 19-50 metres. Provision has been made for an extension loud-speaker and a gramophone pick-up.

The price for the 6-valve A.C. model U650 is 16 guineas; while a D.C. model, U690, is priced at 17 guineas. These all-British receivers are made by Pilot Radio, Ltd., 87 Park Royal Road, London, N.W.10, from whom the full details can be obtained.

FOYLES

BOOKSELLERS TO THE WORLD
Stock of nearly three million new and second-hand volumes. Catalogues free on mentioning your interests.

119-125 Charing Cross Rd., London, W.C.2.
Telephone: Gerrard 5660(12 lines)



FOREMOST AS PIONEERS

SCREEN GRID BATTERY 3 WITH PENTODE OUTPUT VALVE. Incorporating our new BP 114 Unit. Send today for blueprint. Price 3d. Post Free.

OLIVER PELL CONTROL, LTD., BLOOMFIELD ROAD, WOOLWICH, S.E.18 WOOLWICH 2345

TELEVISION DEVELOPMENTS

A NEW LARGE DIAMETER TUBE FOR TELEVISION REPRODUCTION



TYPE 12H TUBE

The Ediswan Type 12H tube has a screen diameter of 12" giving a television picture 10" x 7½" without distortion.

The screen is of special material giving a close approximation to a black-and-white picture.

Specification:

Indirectly heated high vacuum tube.
Heater Volts - - - 2.0
3rd Anode Volts - - - 6000
2nd Anode Volts - - - 1200
1st Anode Volts - - - 150-400
Sensitivity (mm./V.) - - 950/V*

*V = anode volts

List Price £15. 15. 0

● We also supply
HIGH VACUUM RECTIFIERS
GAS-FILLED RELAYS
MERCURY VAPOUR RELAYS
for Television Scanning
circuits.

ENTIRELY BRITISH MADE

EDISWAN RADIO VALVES

THE EDISON SWAN ELECTRIC CO. LTD.  155 CHARING CROSS RD., LONDON, W.C.2

R.E.299

USED BY ALL GOVERNMENT DEPARTMENTS

Printed in Great Britain for the Proprietors and Publishers, BERNARD JONES PUBLICATIONS, LTD., Chandos House, Chancery Lane, London, W.C.2, by THE PRESS AT COOMBELANDS LTD., Addlestone, Surrey. Sole Agents for South Africa: CENTRAL NEWS AGENCY, LTD. Sole Agents for Australia and New Zealand: GORDON AND GOTCH (AUSTRALASIA), LTD.